

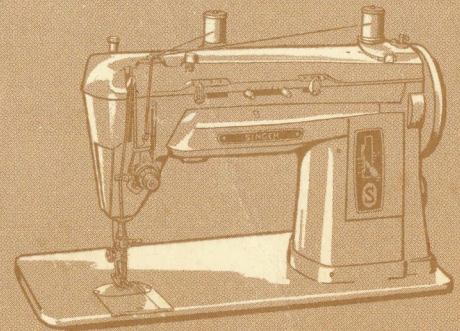

SINGER

402G



THE SINGER MANUFACTURING COMPANY



SINGER*
Sewing Machine
402*

THE SINGER MANUFACTURING COMPANY

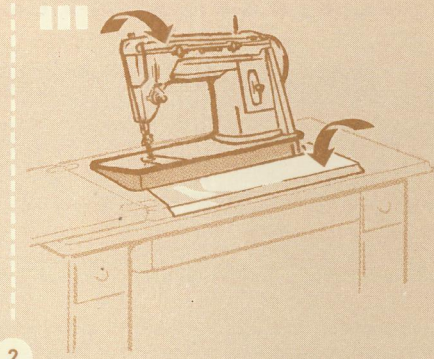
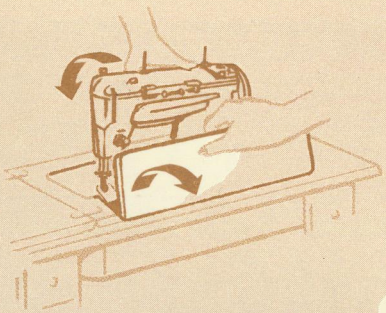
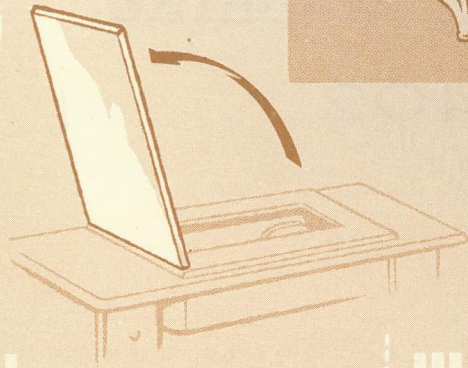
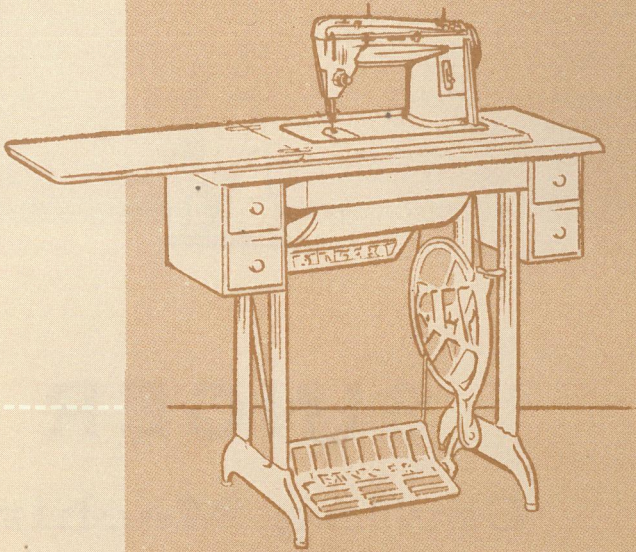

2

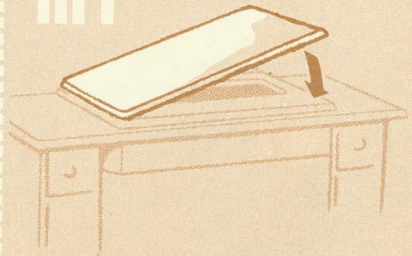
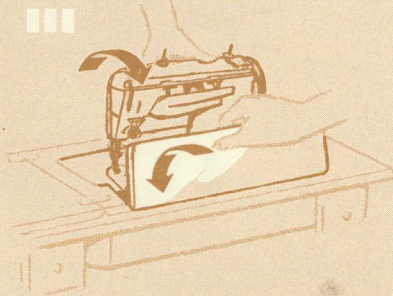
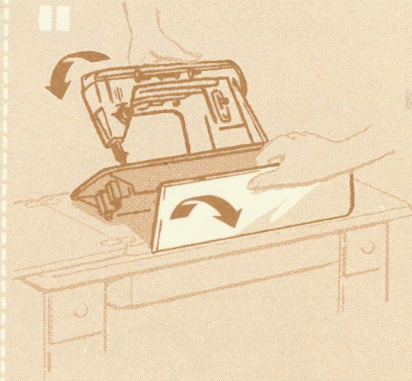
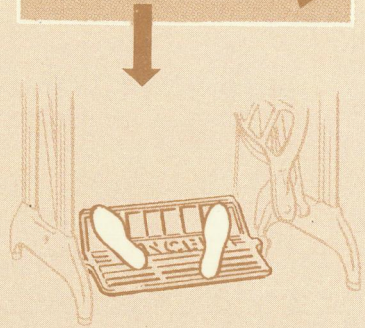
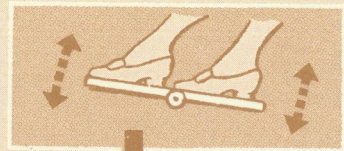

3

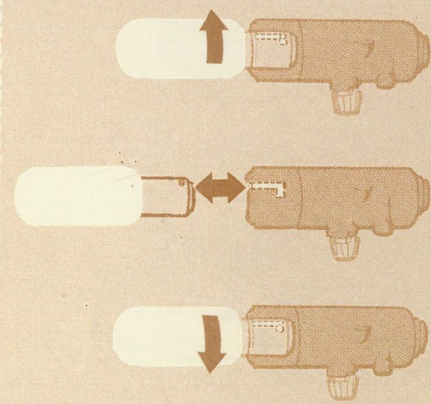
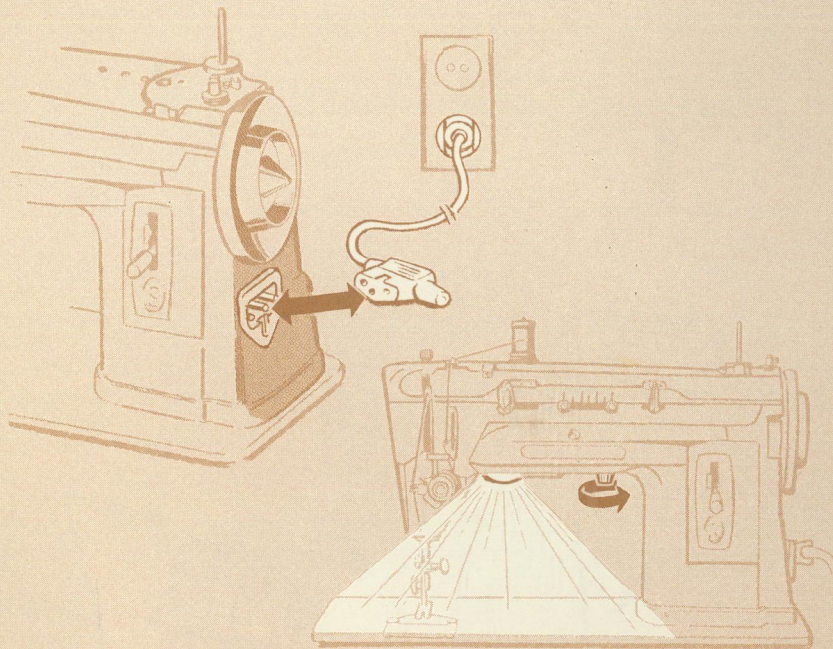

4

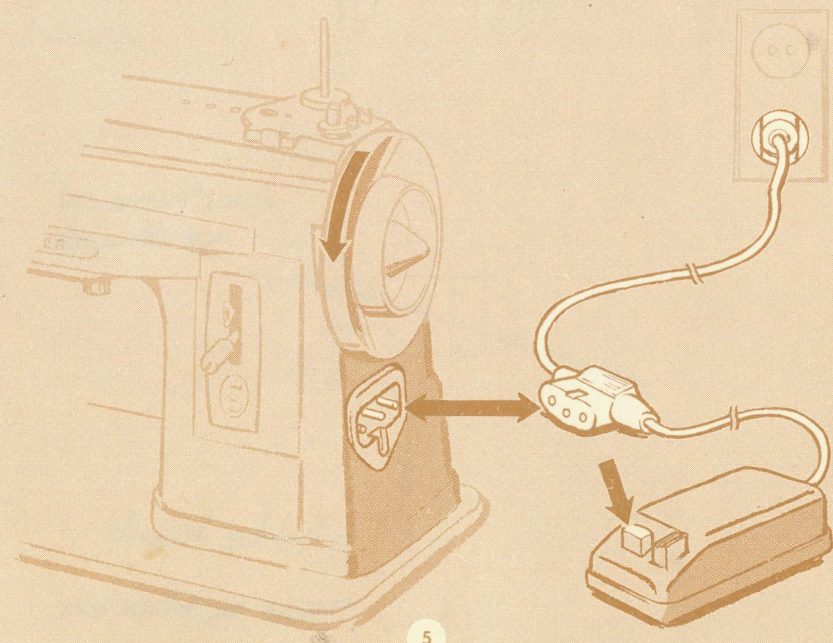
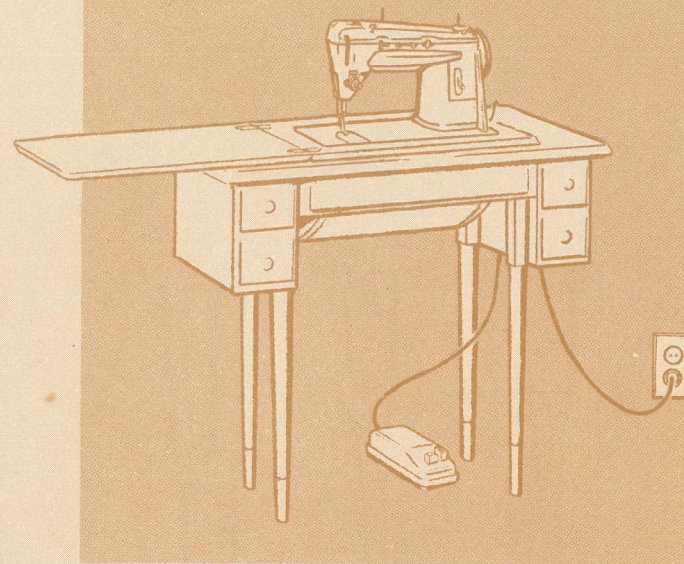

5

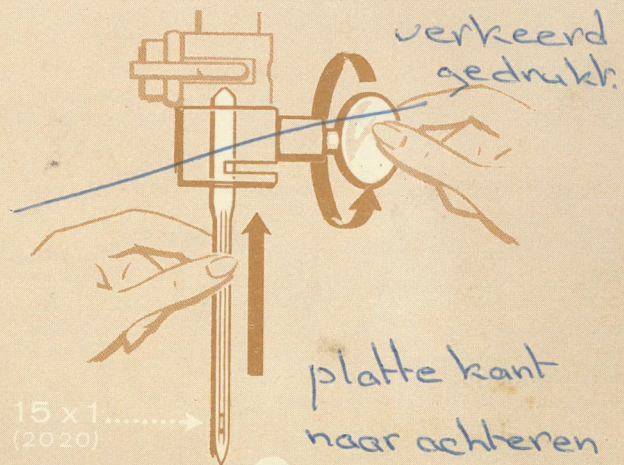
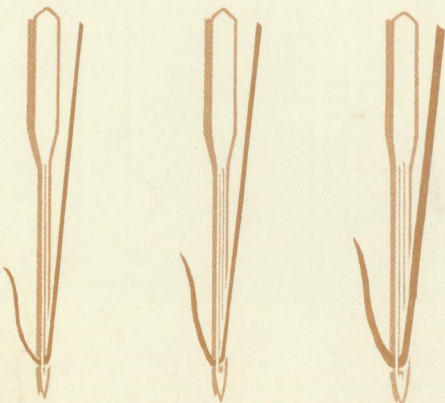

6

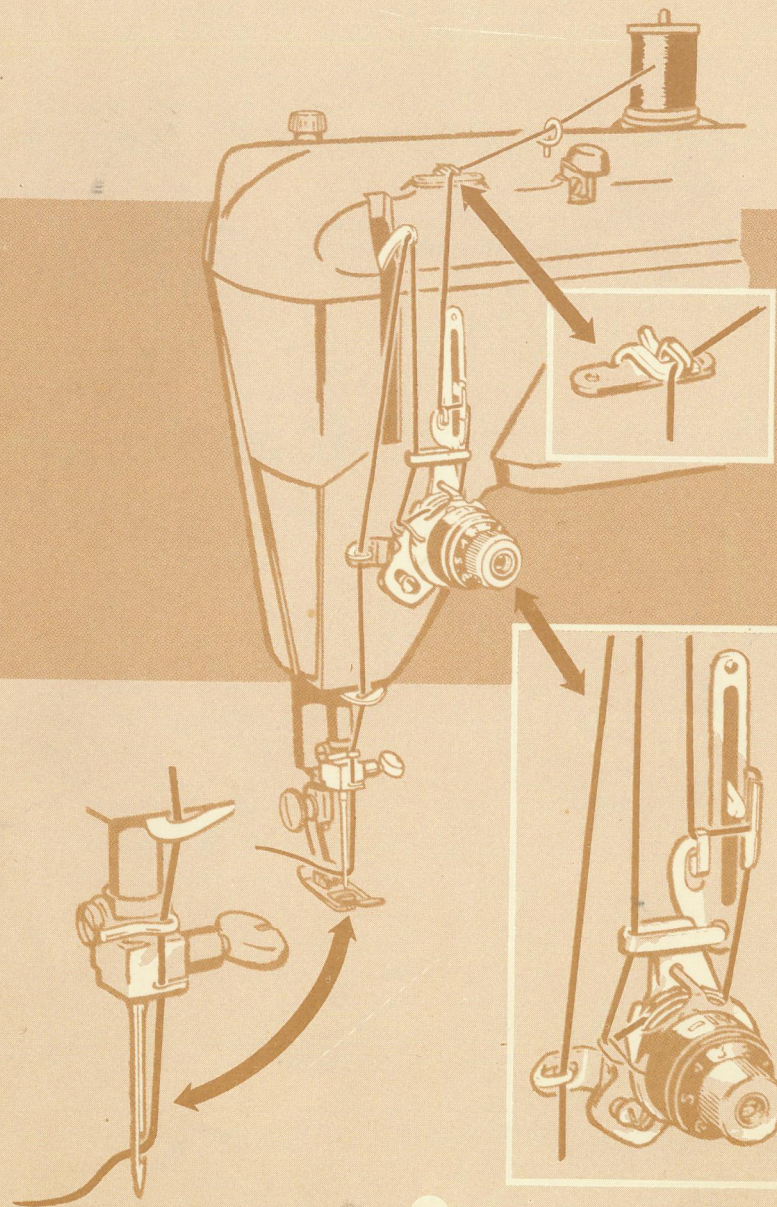

7

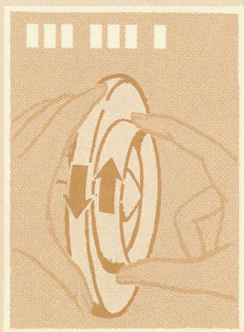
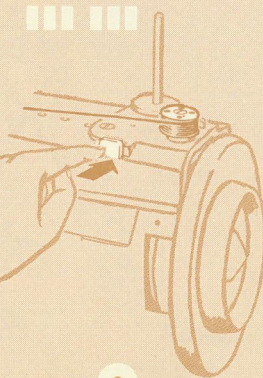
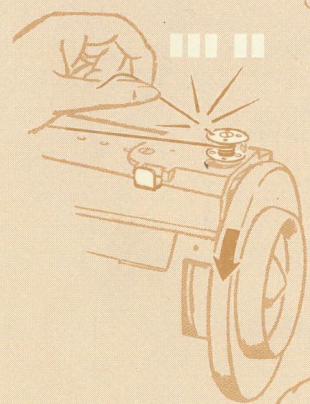
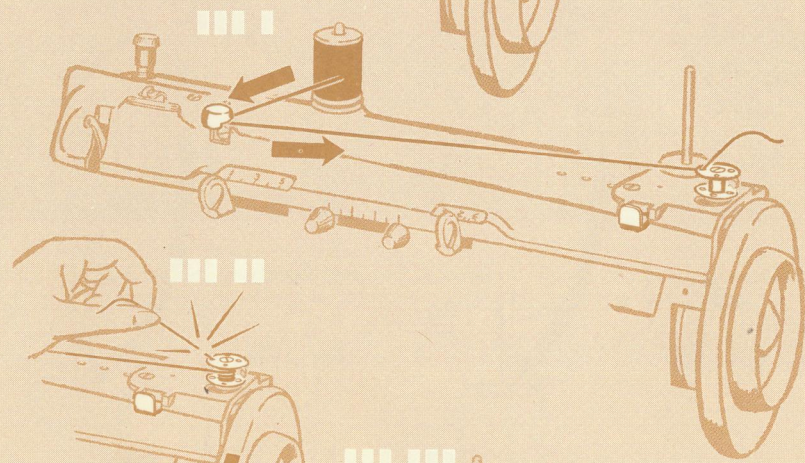
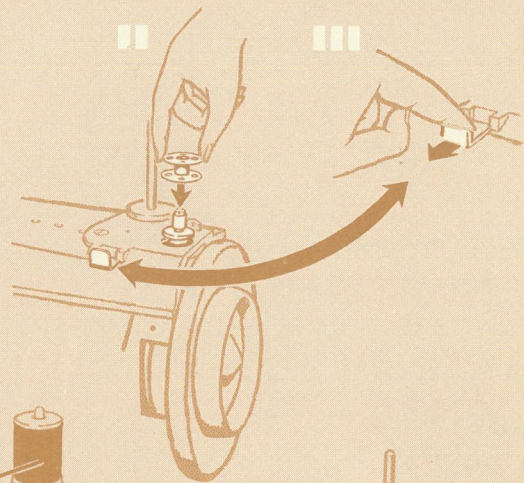
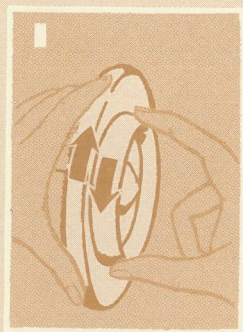
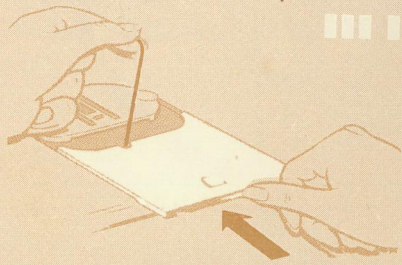
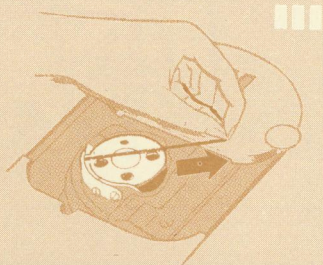
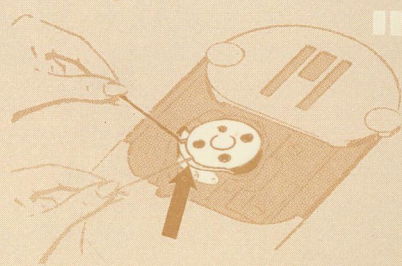
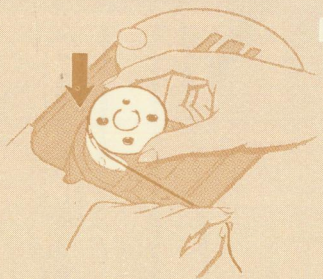
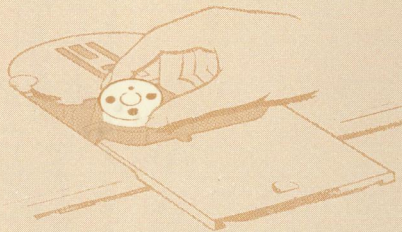
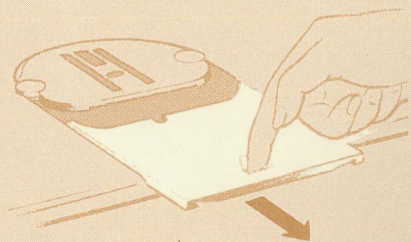
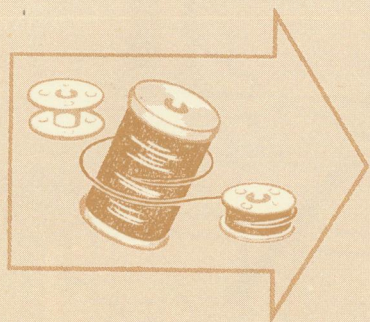

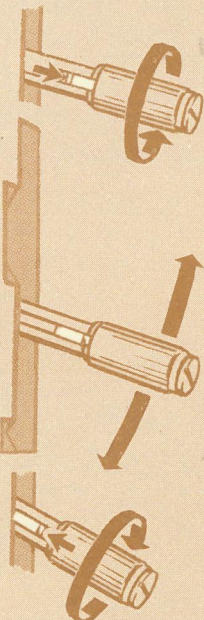
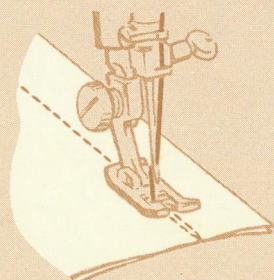
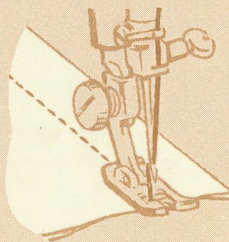
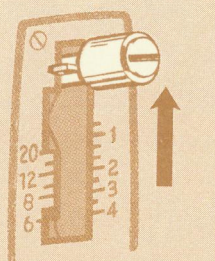
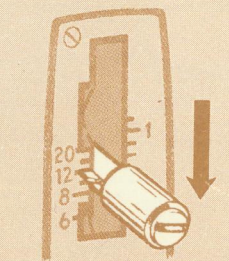
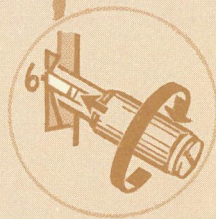
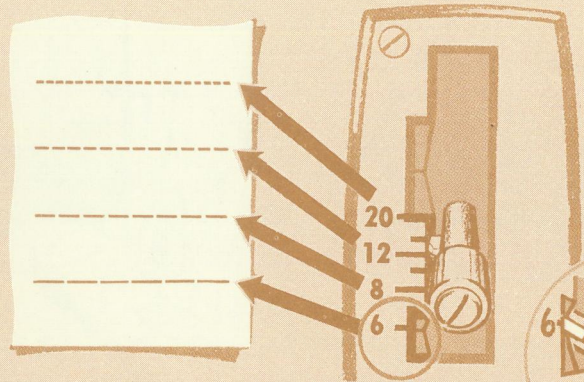
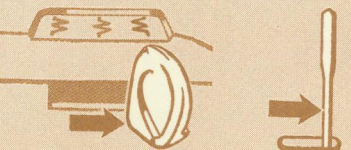
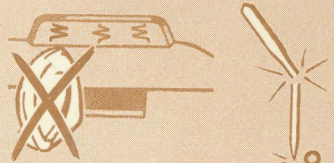
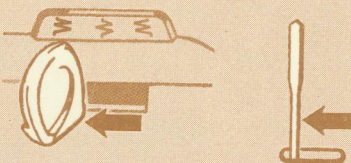
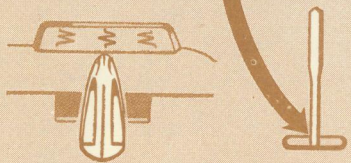
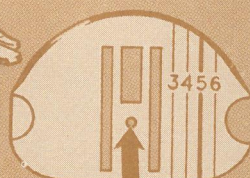
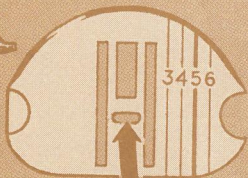
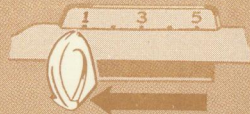
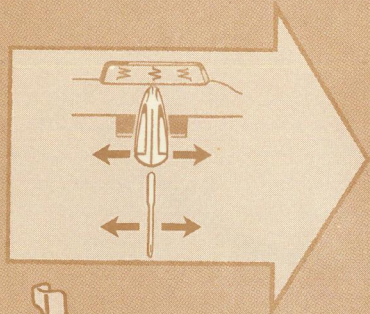

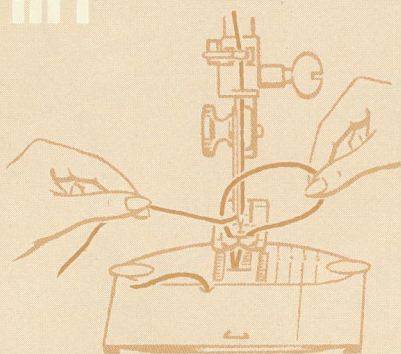
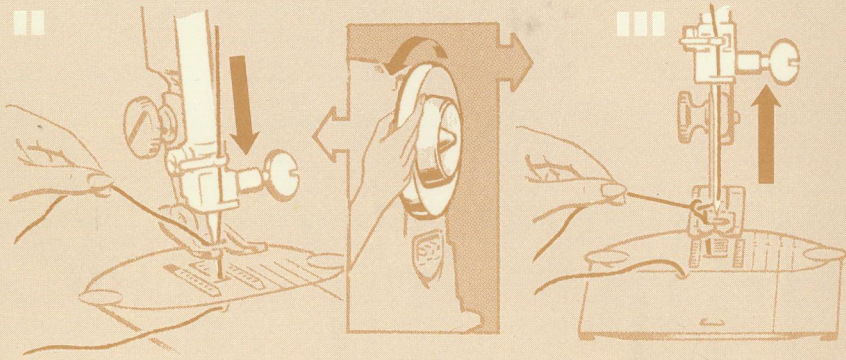
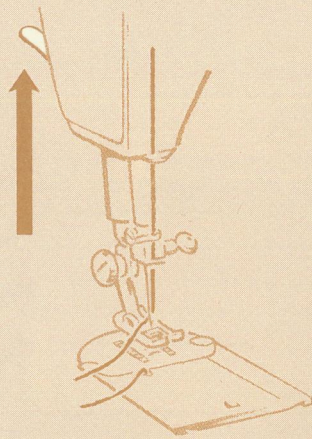
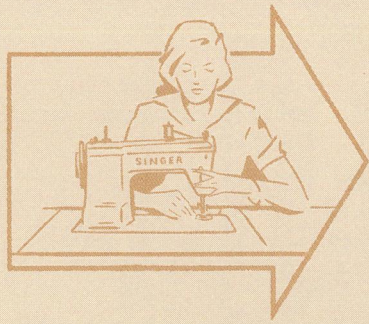

12

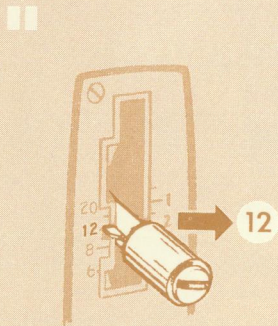
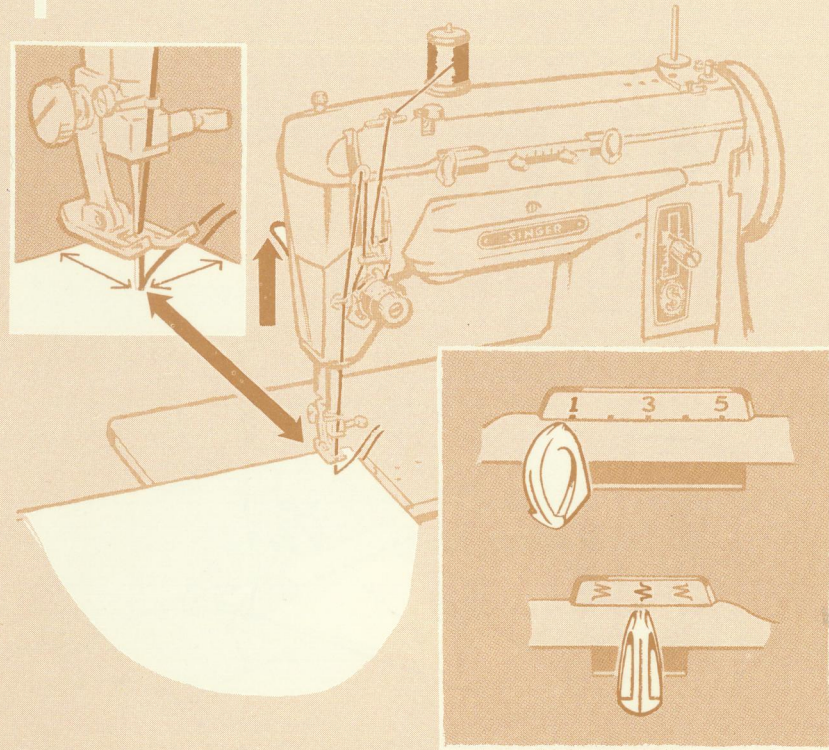
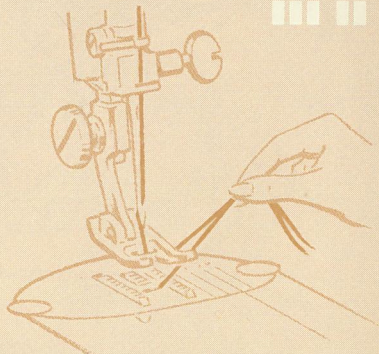

12

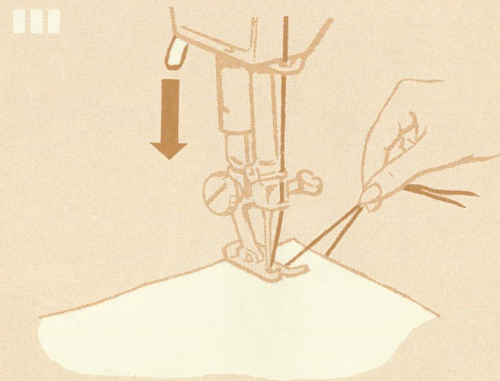

13

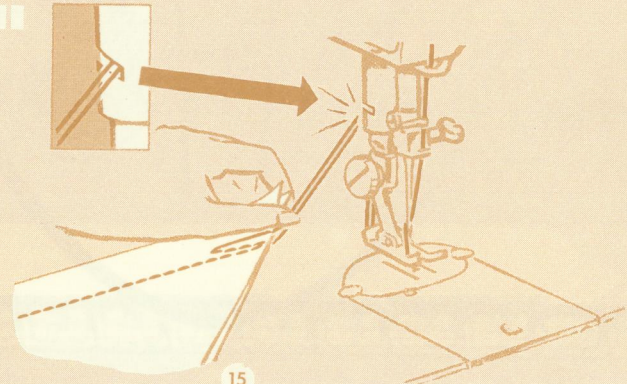
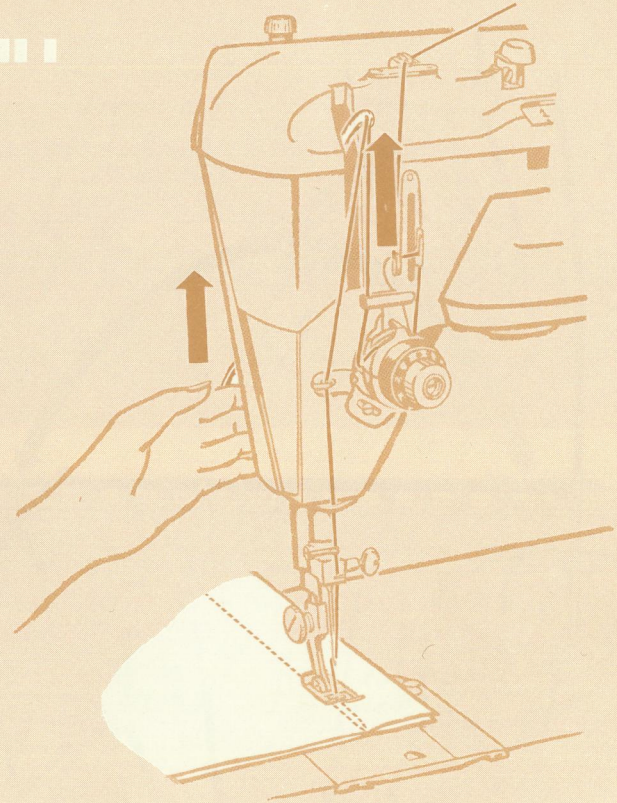
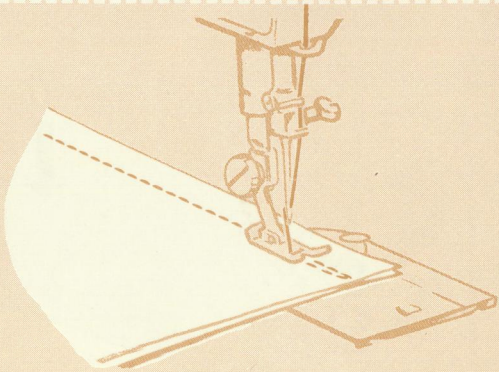
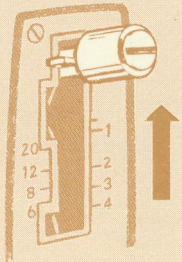
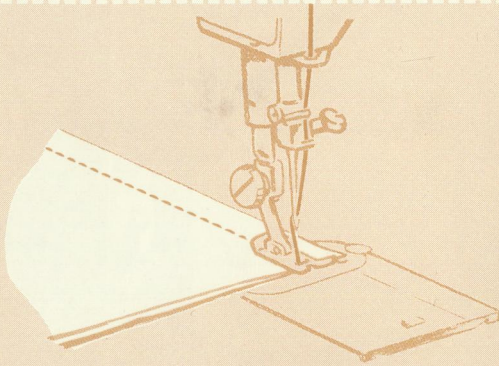
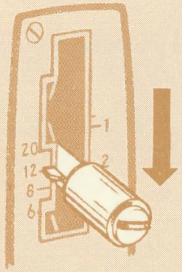
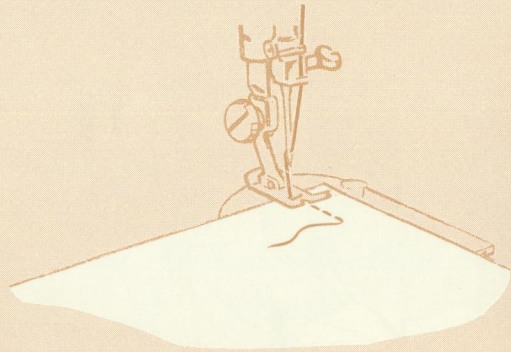
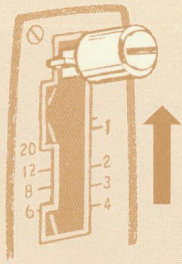

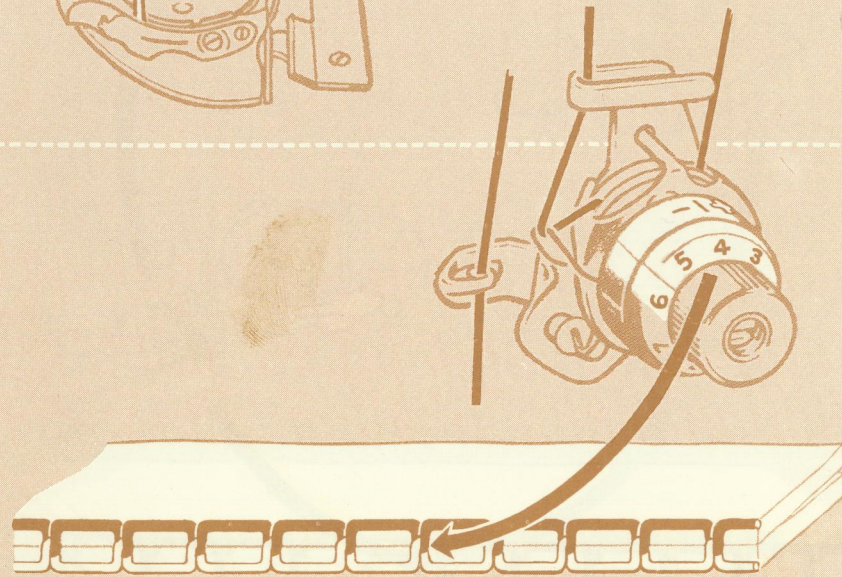
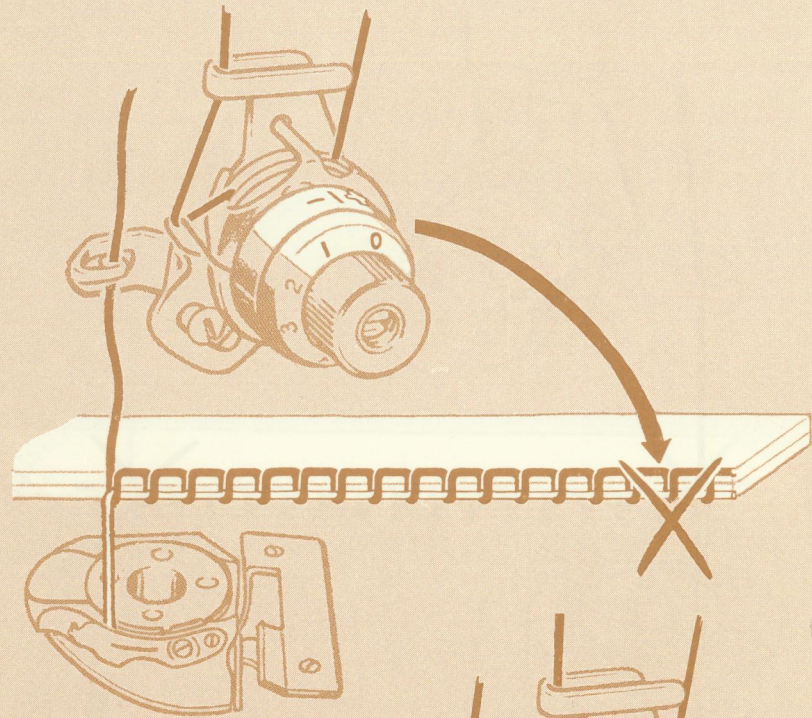
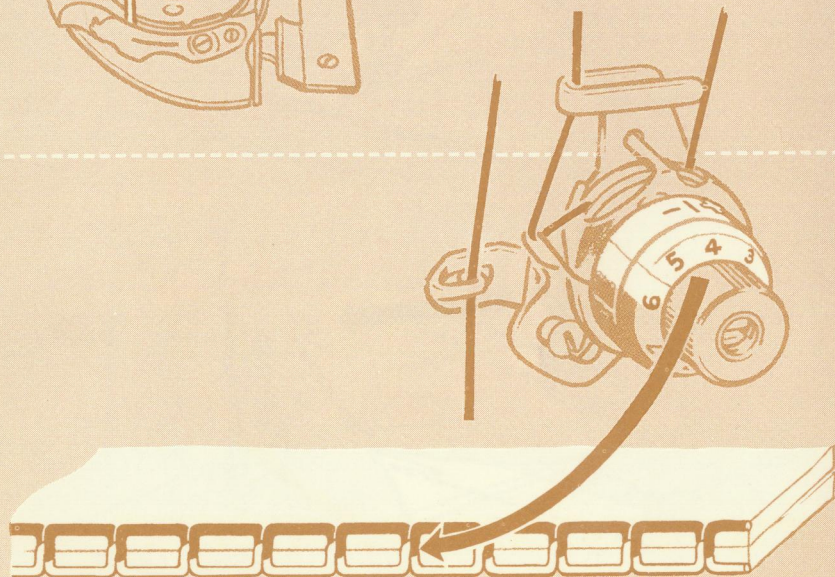
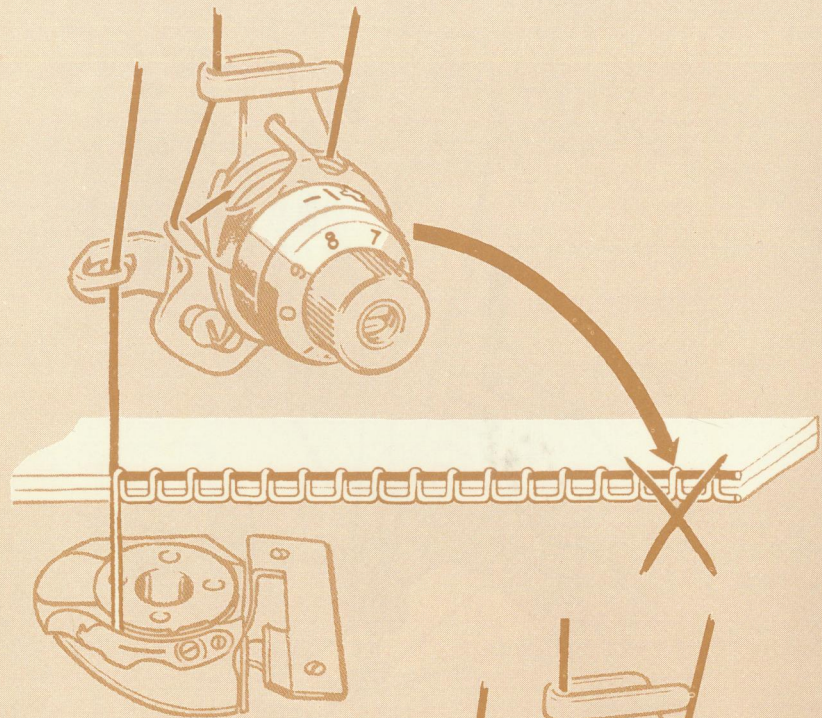

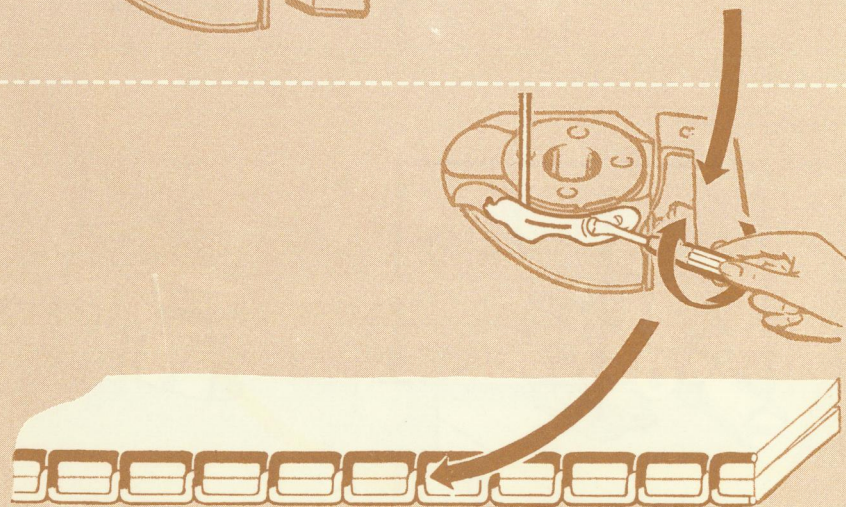
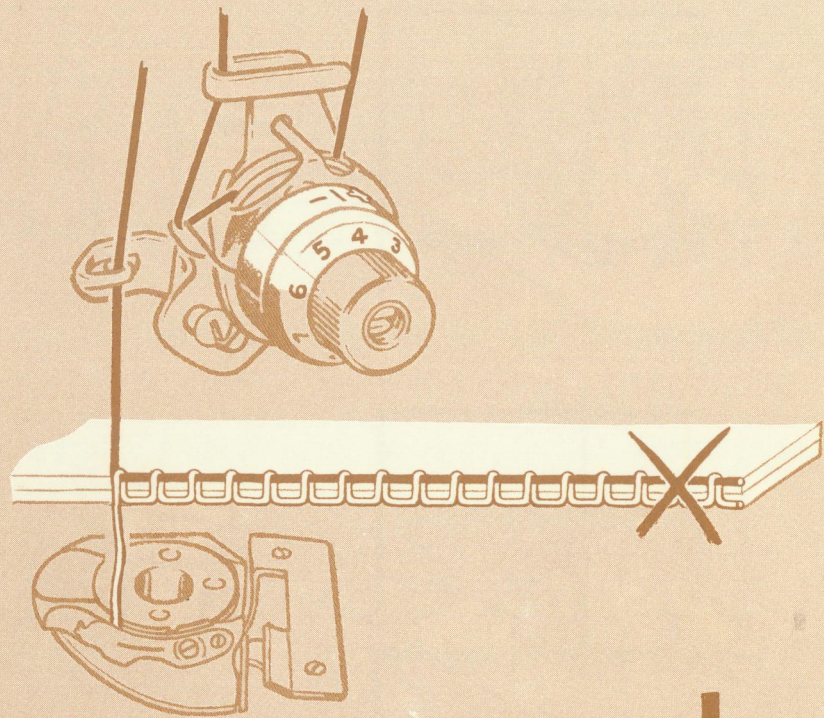
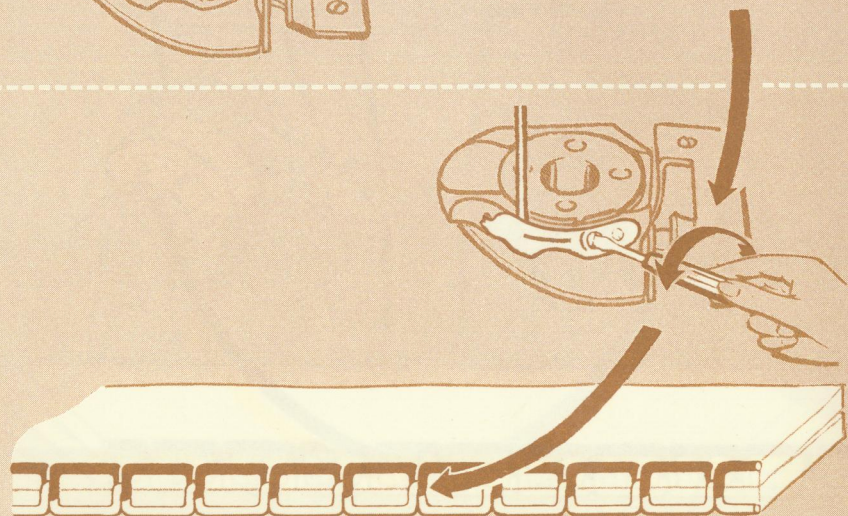
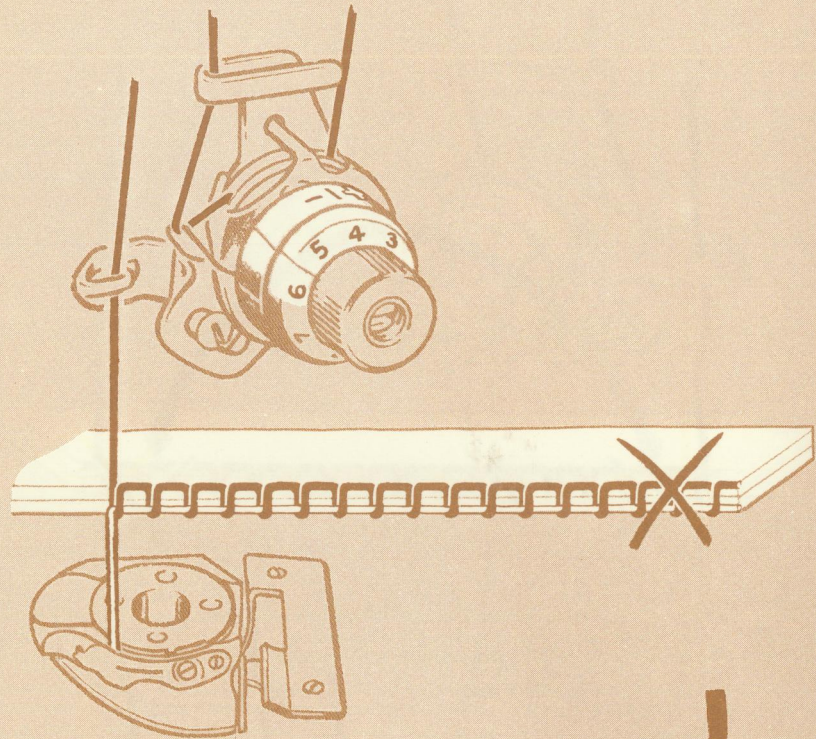

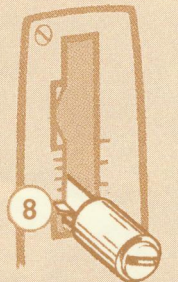
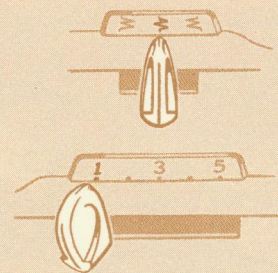
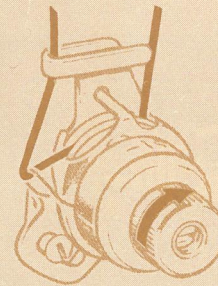
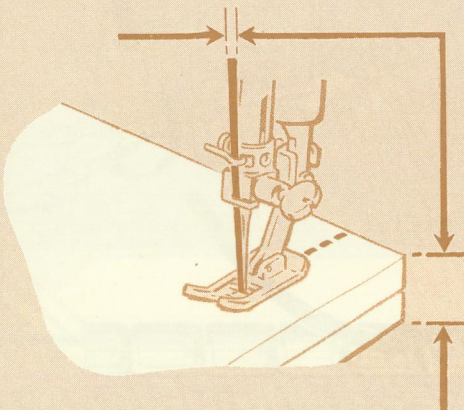
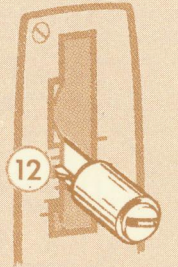
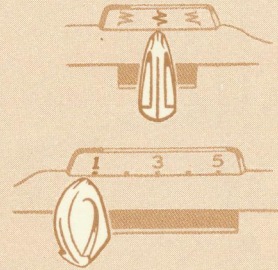
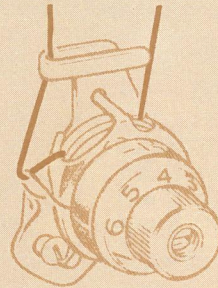
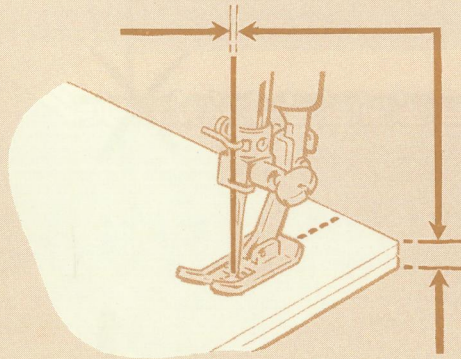
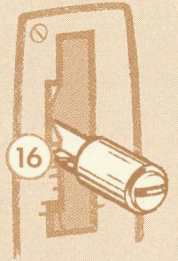
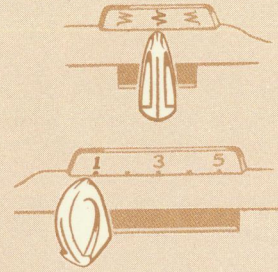
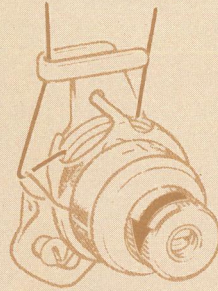
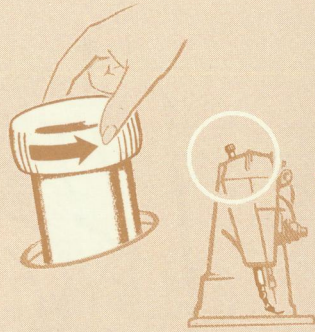
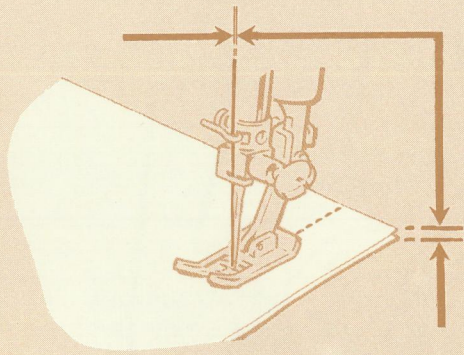

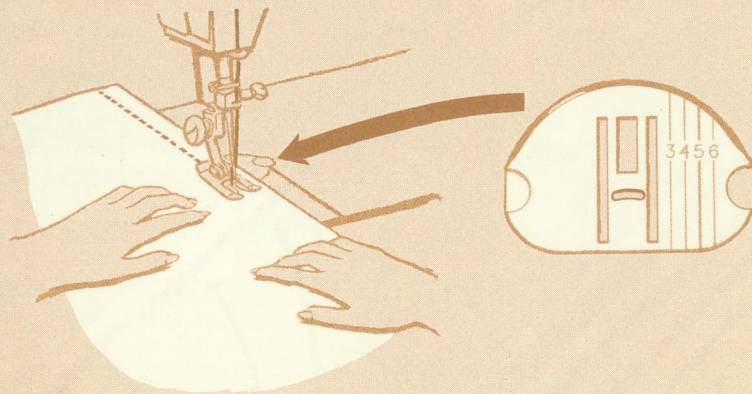
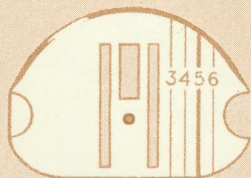
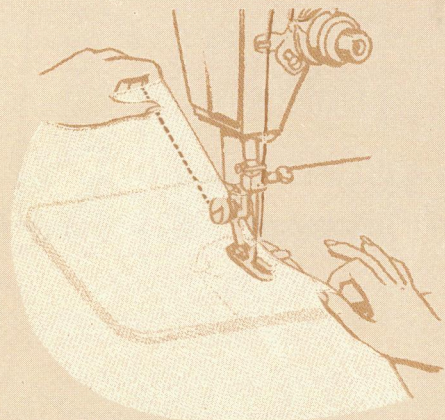
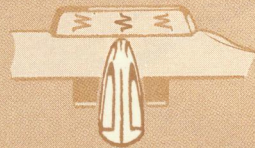
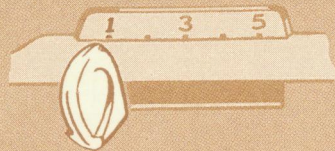
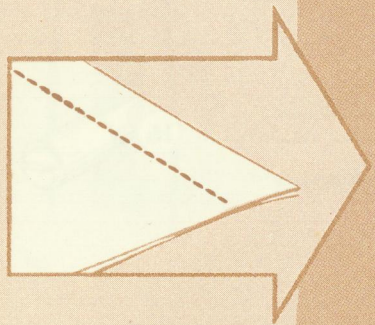

22

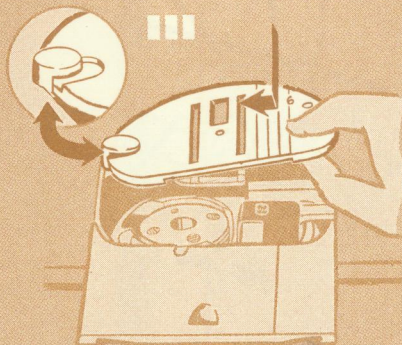
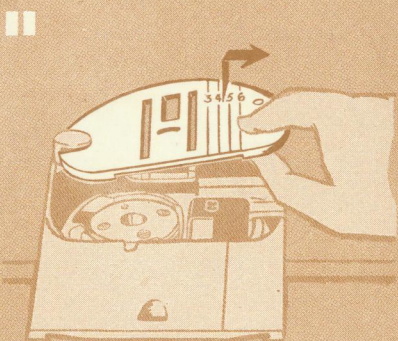

23

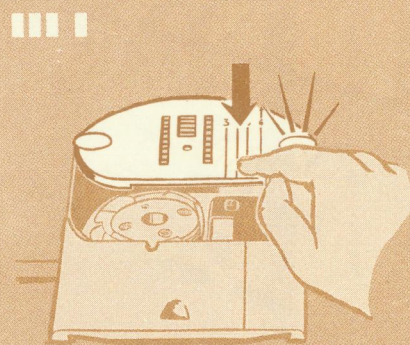

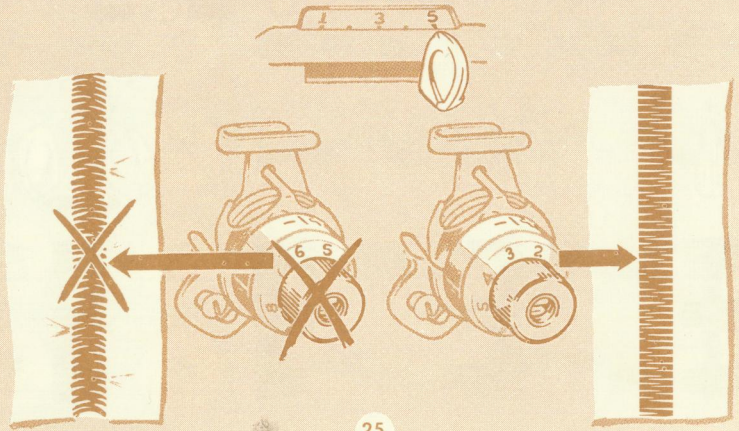
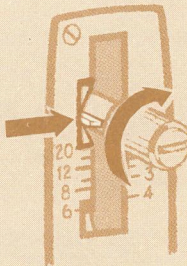
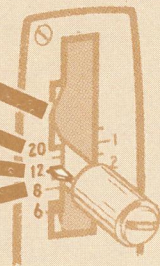
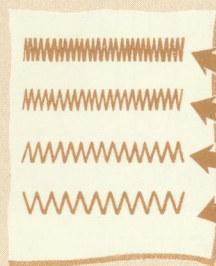
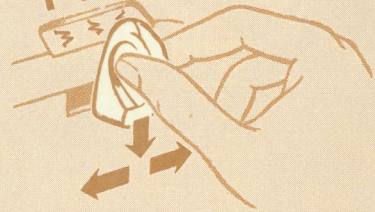
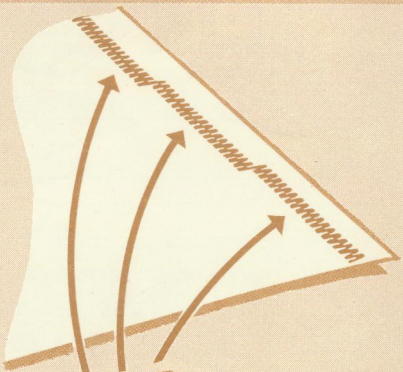
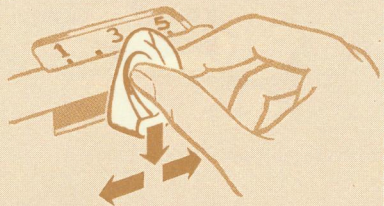
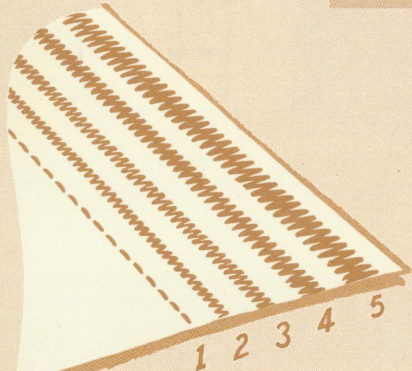
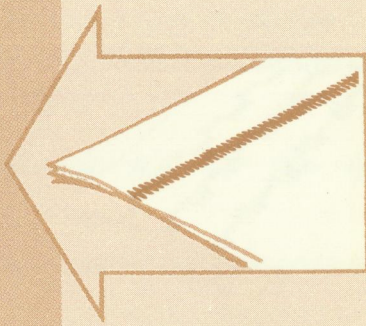
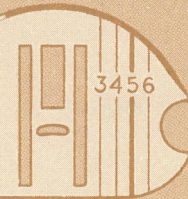
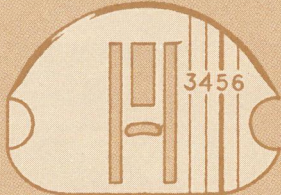
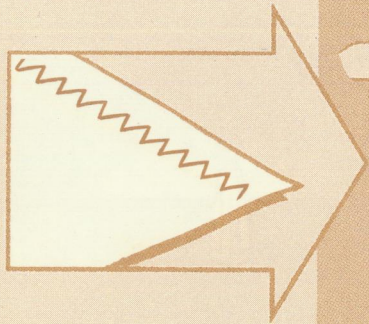

Handwritten text in a large arrow pointing right, likely a title or instruction.

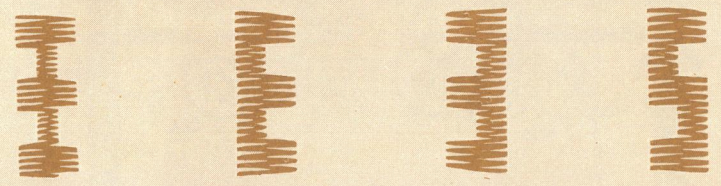
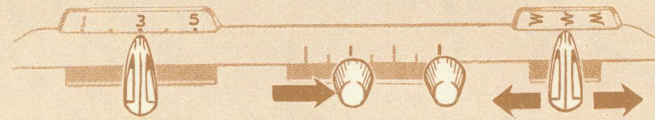
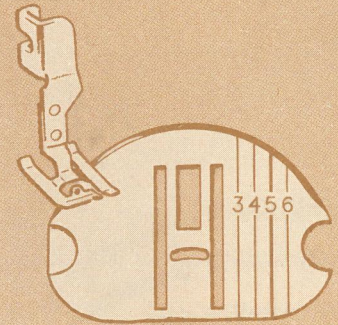
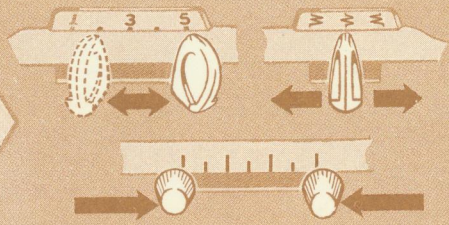

Geen dubbele naald.
Dubbele naald niet verder
als 3.

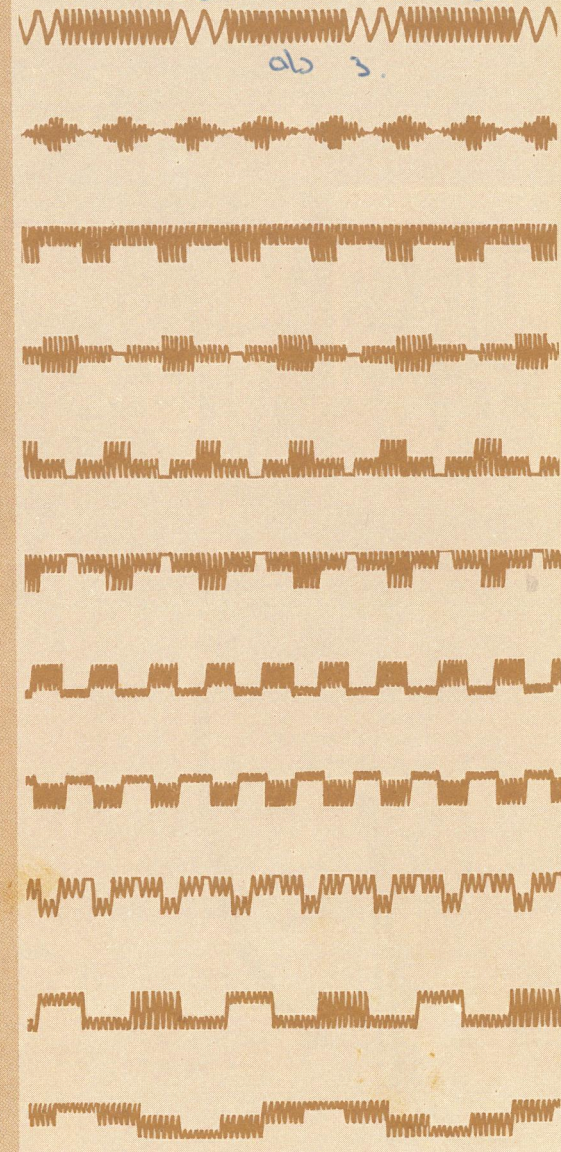
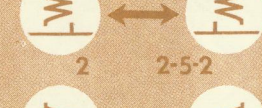
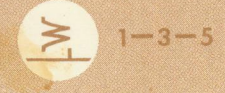

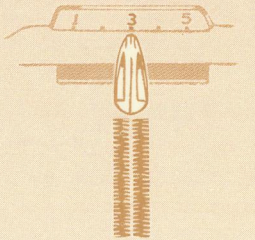
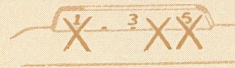
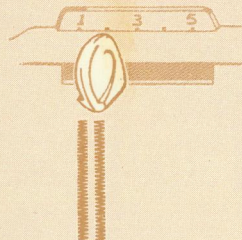
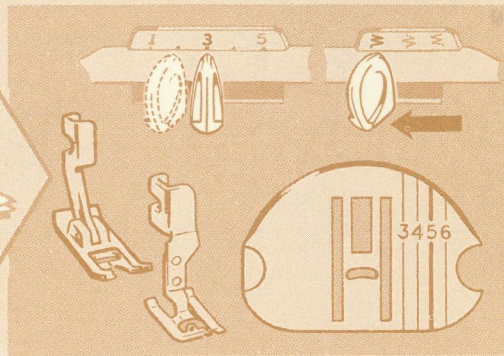
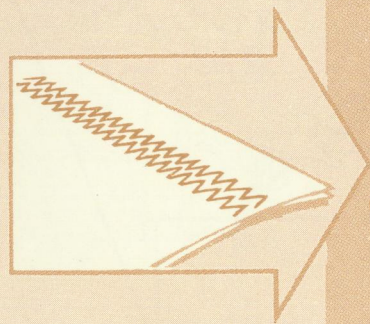
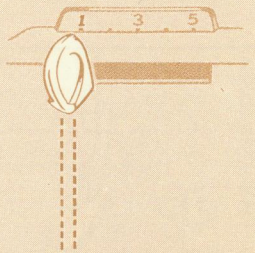
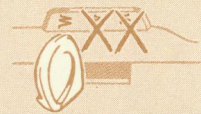
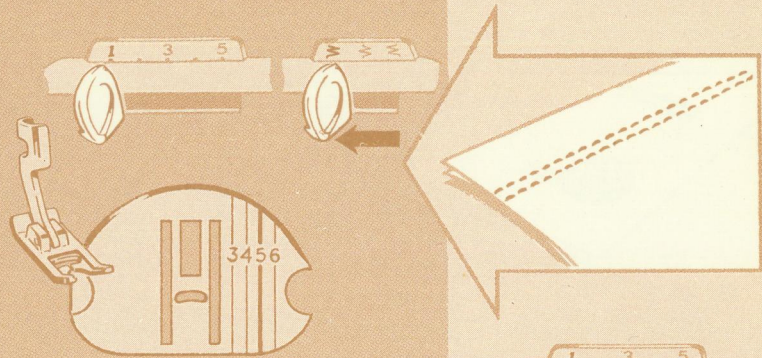
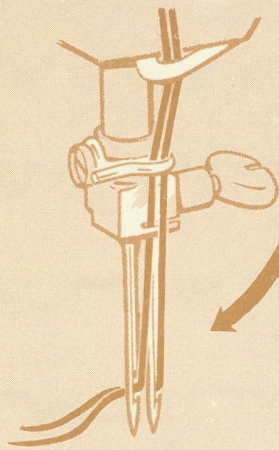
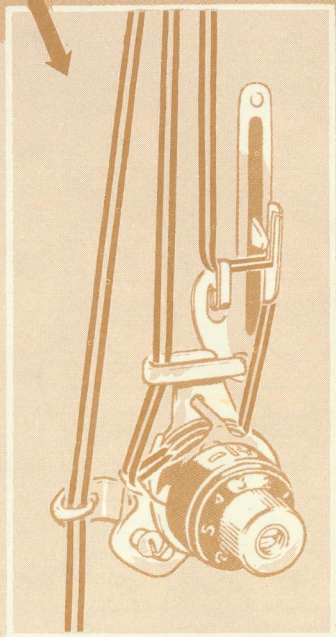
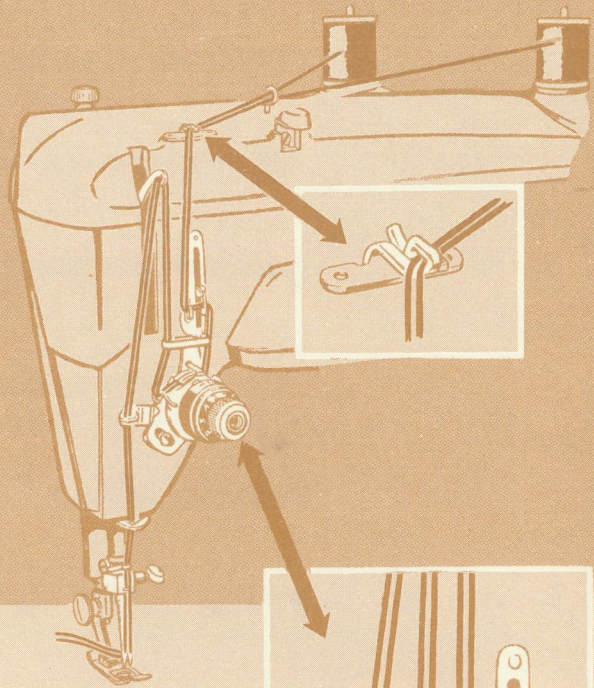
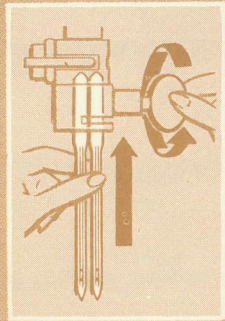

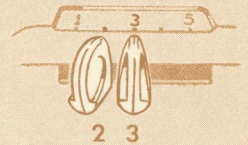
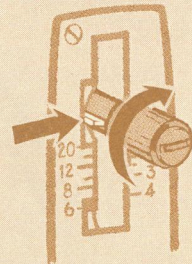
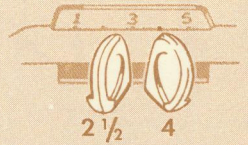
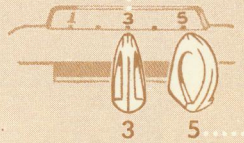
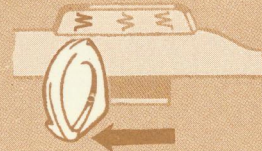
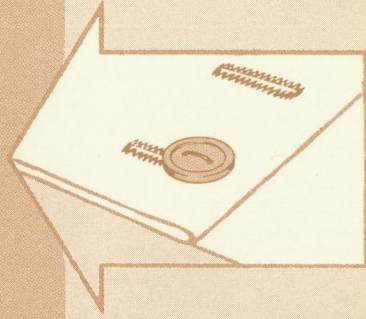
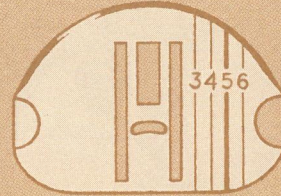
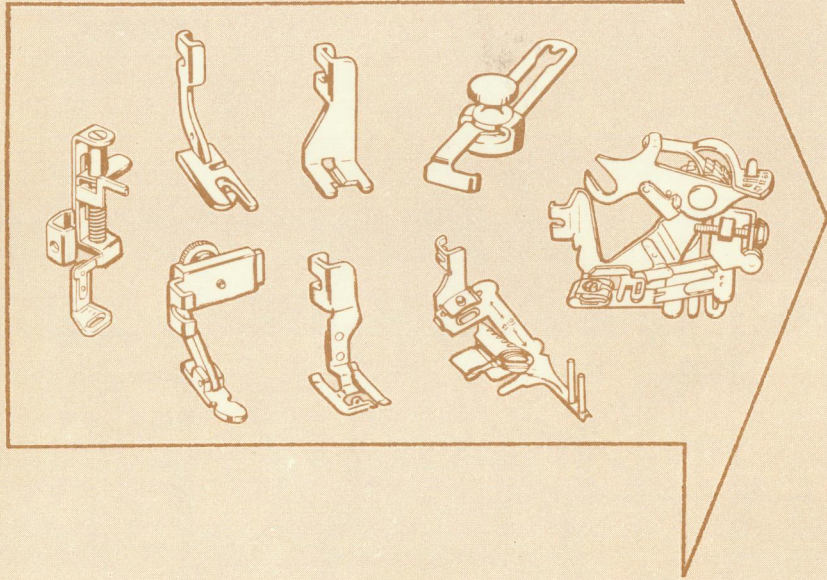

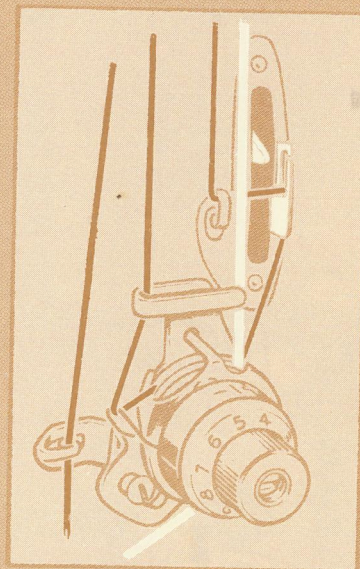
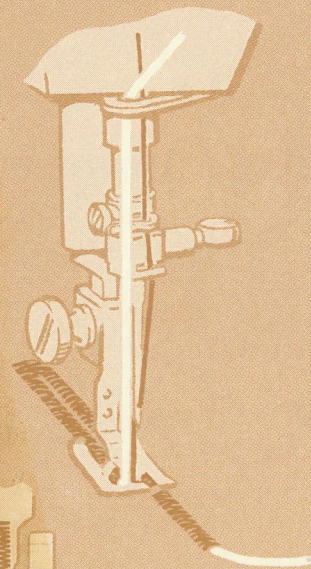
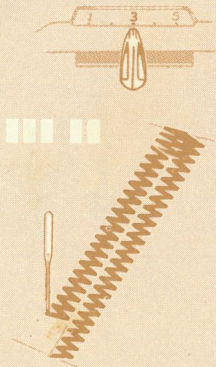
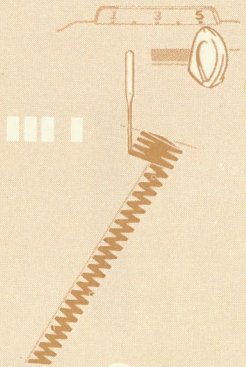
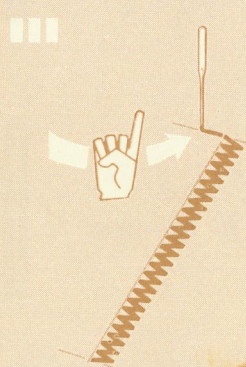
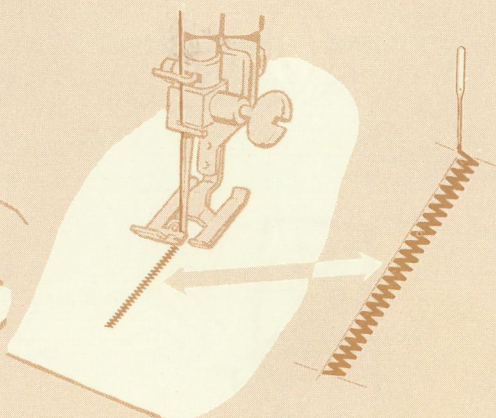
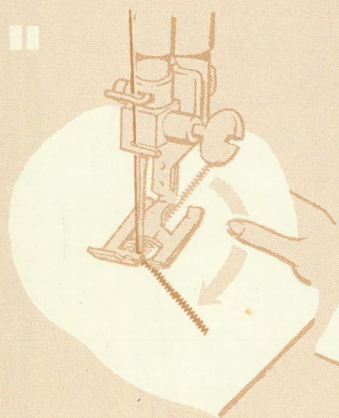
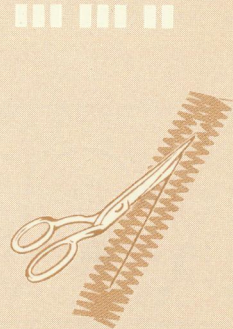
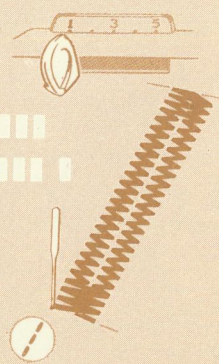
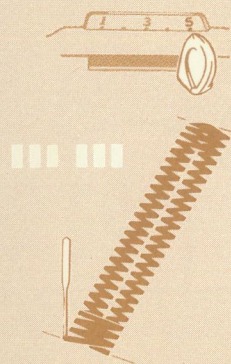
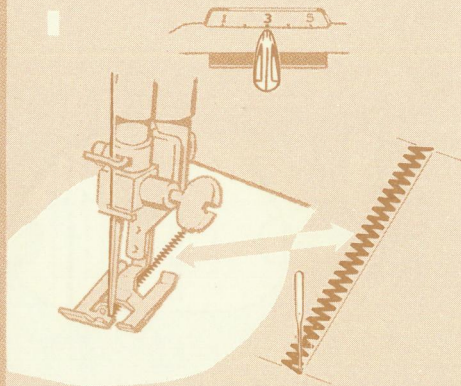
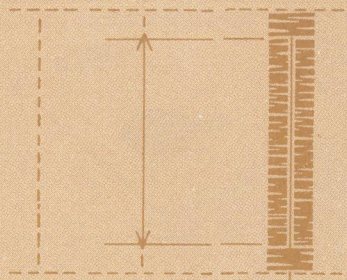

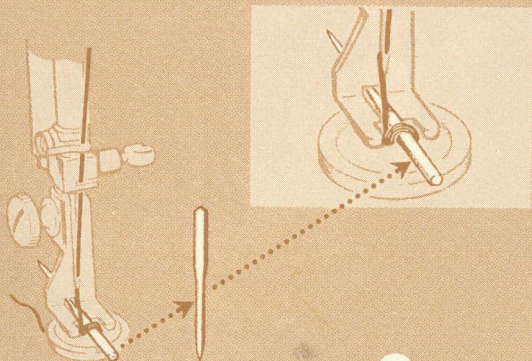
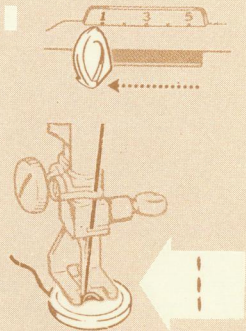
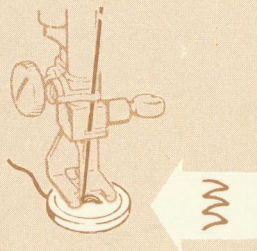
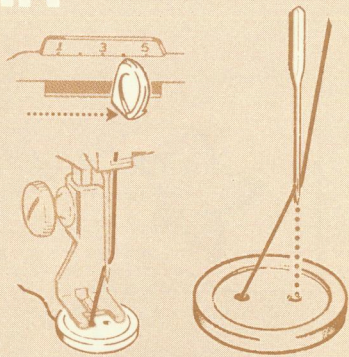
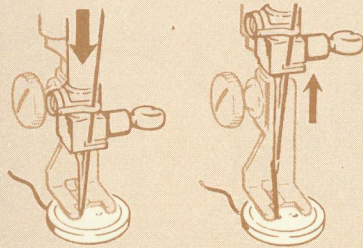
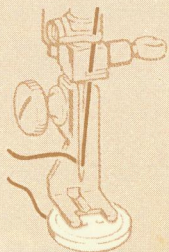
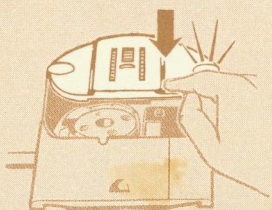
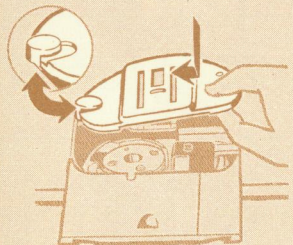
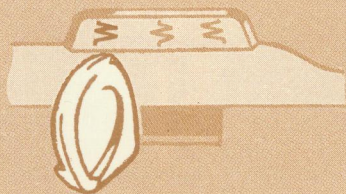
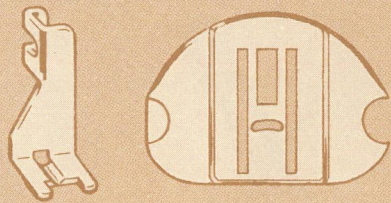
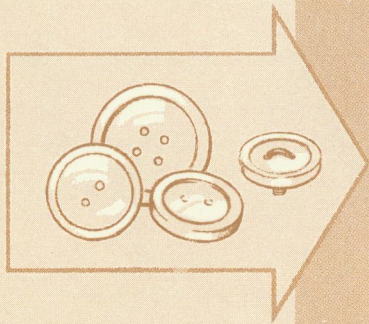

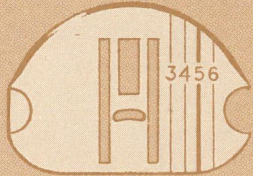
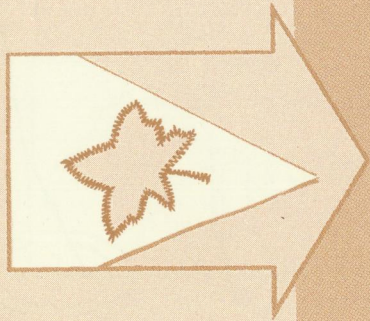

II

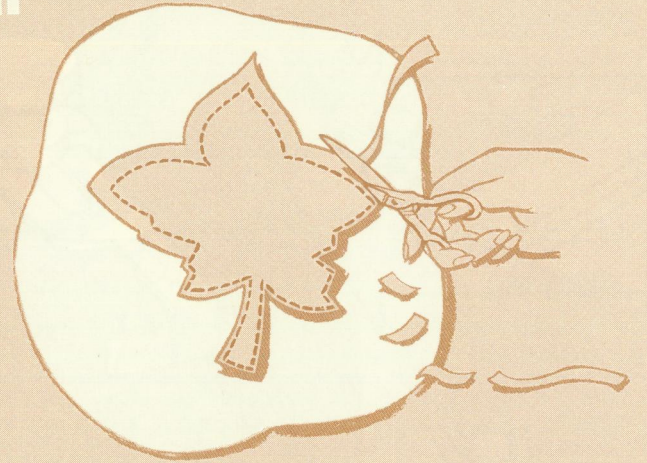

III

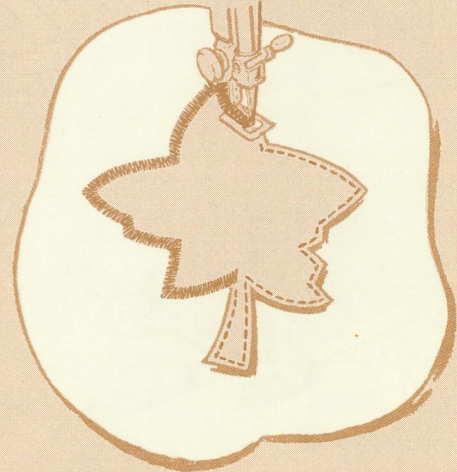
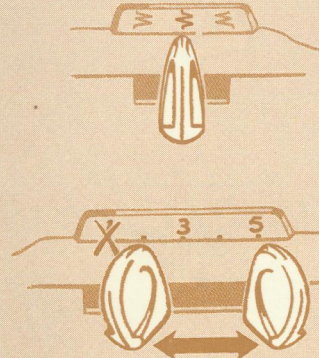
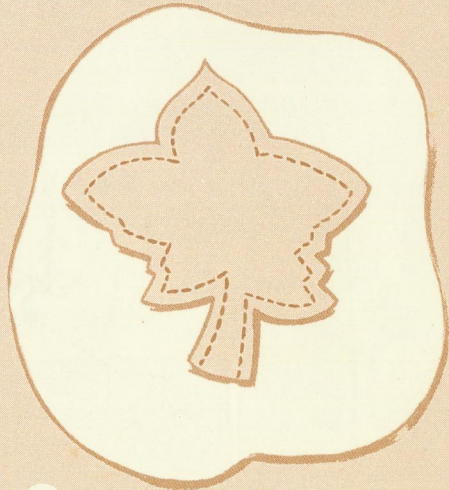
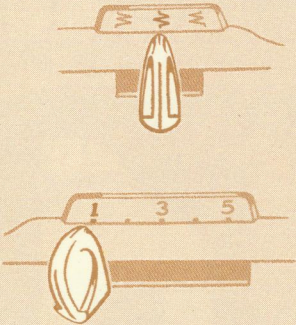

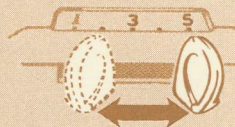
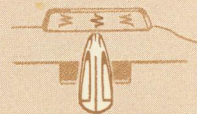
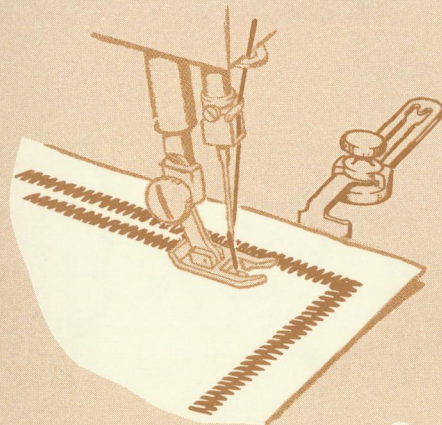
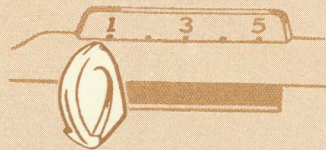
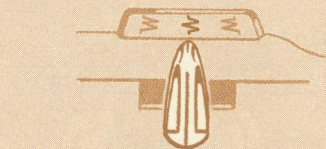
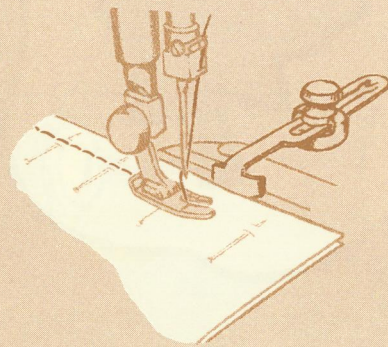
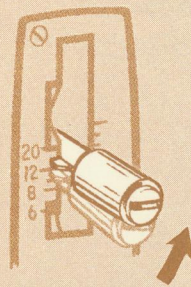
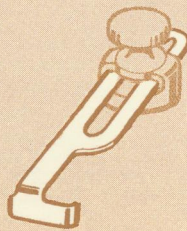
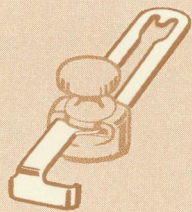
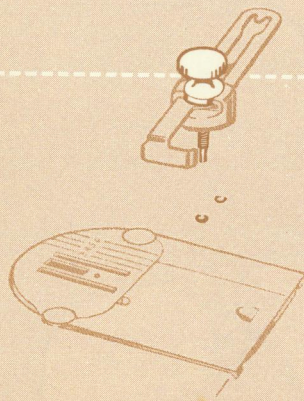
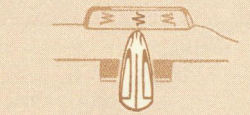
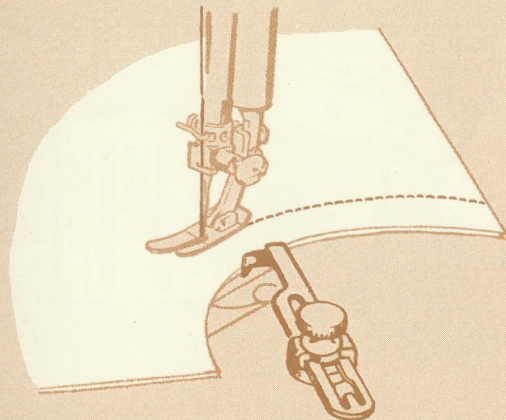
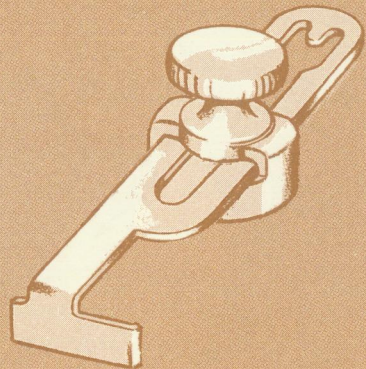
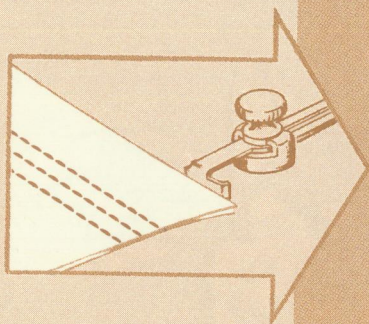

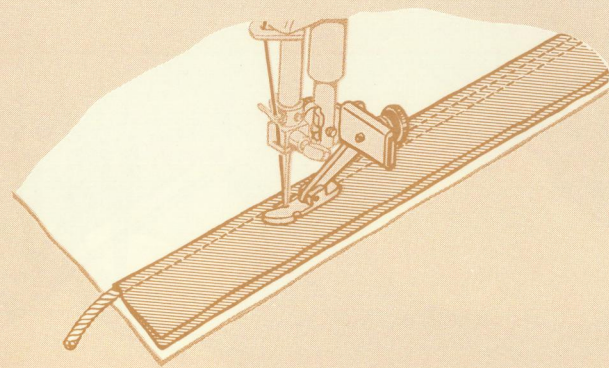
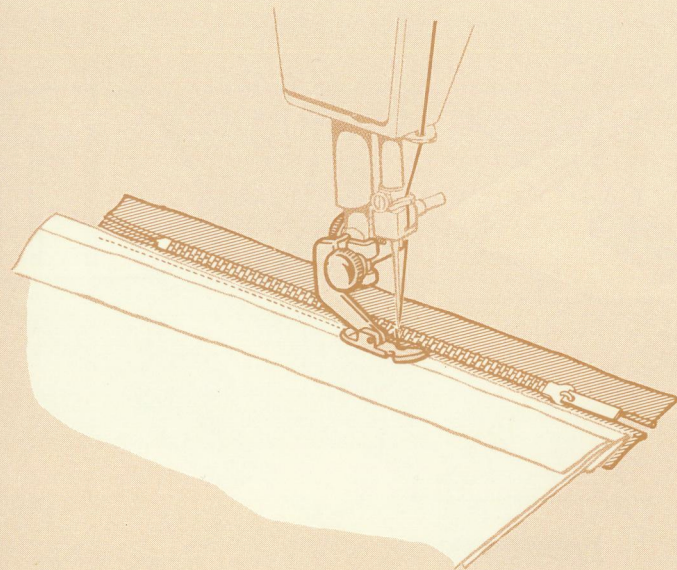
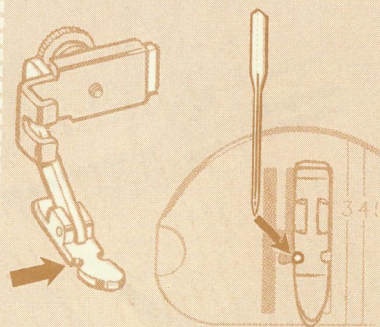
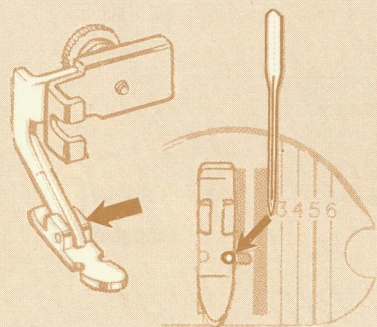
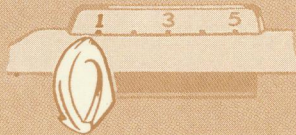
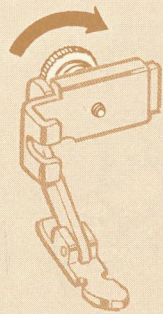
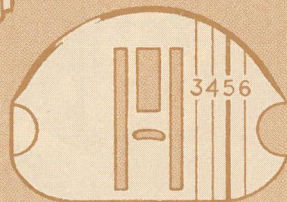
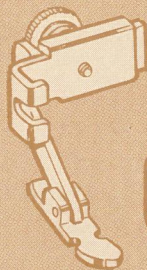
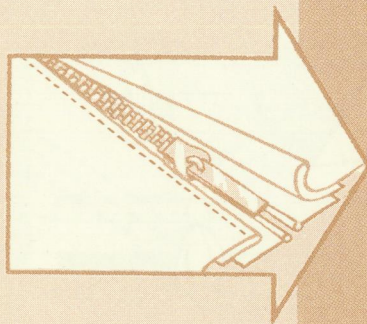

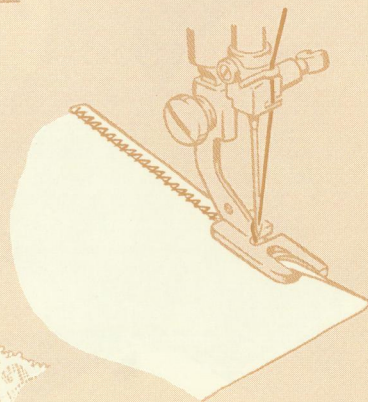
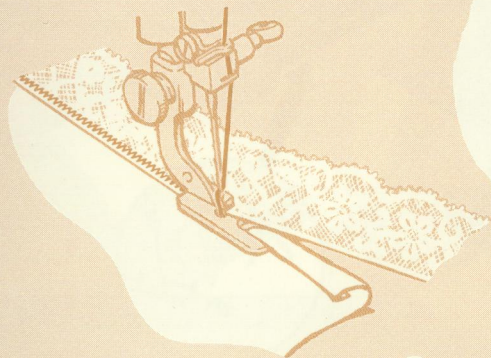
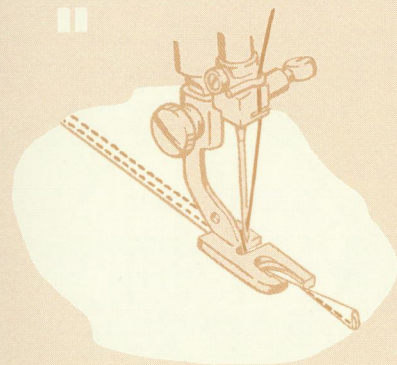
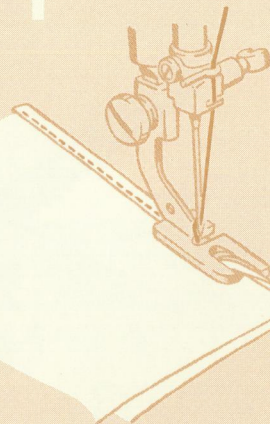
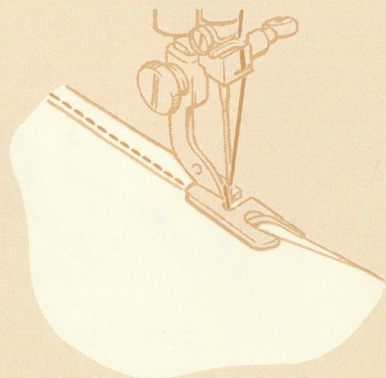
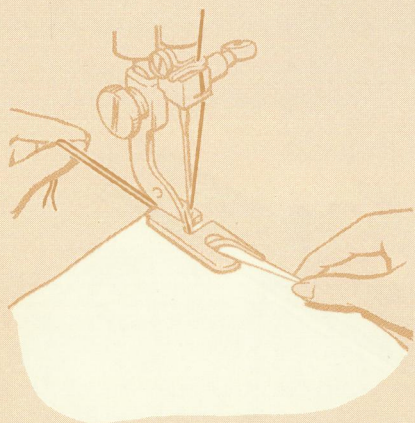
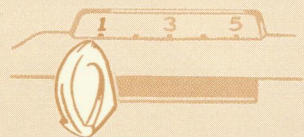
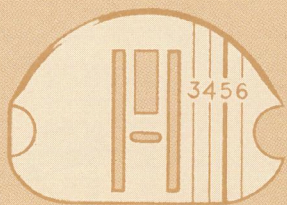
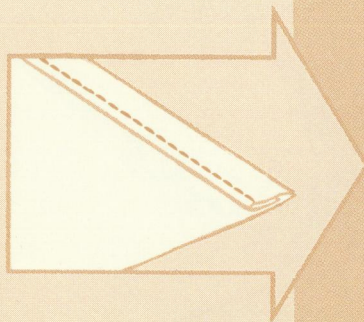

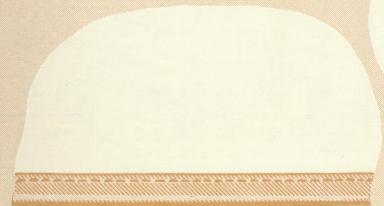
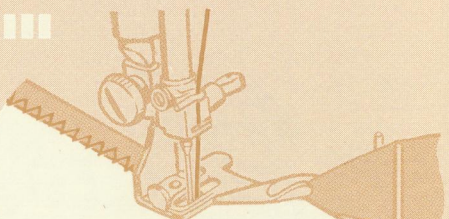
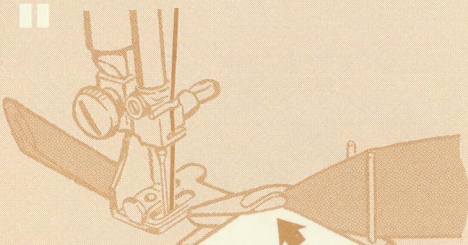
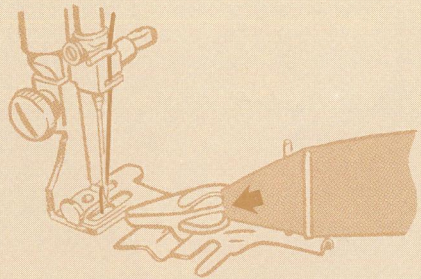
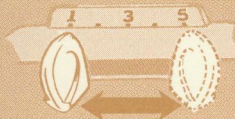
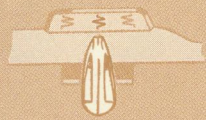
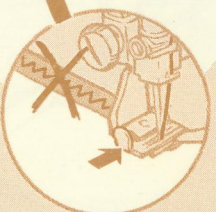
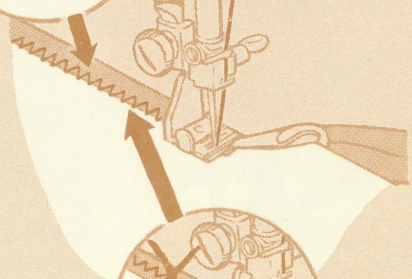
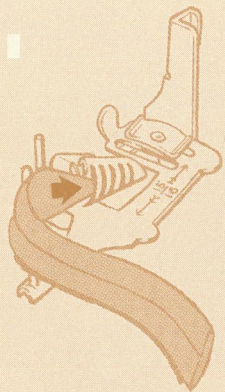
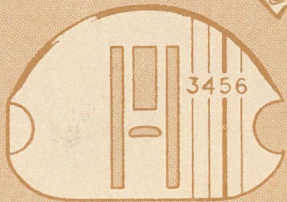
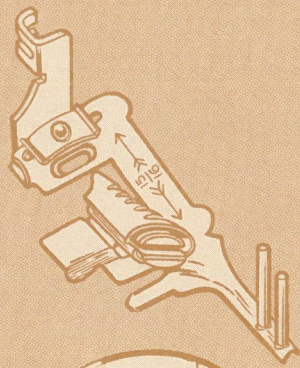
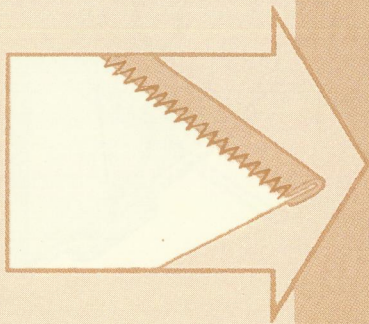

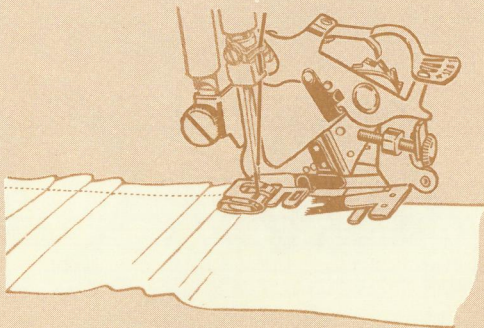
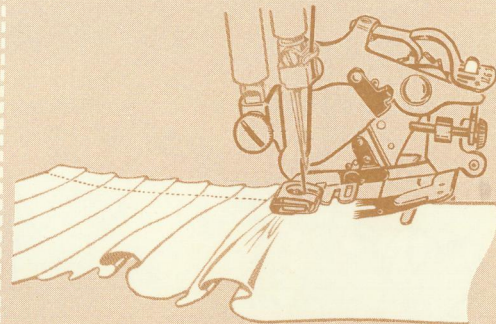
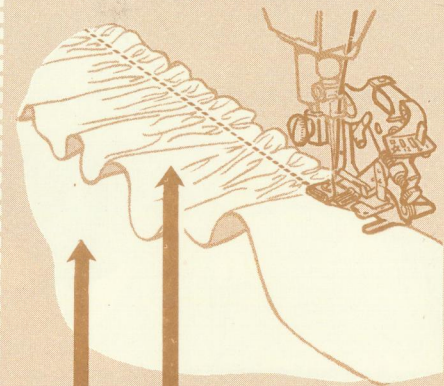
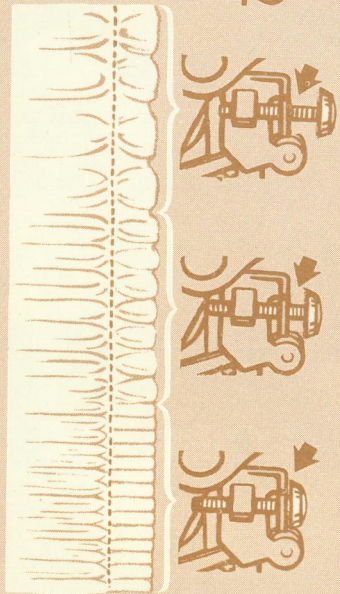
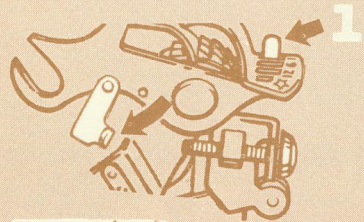
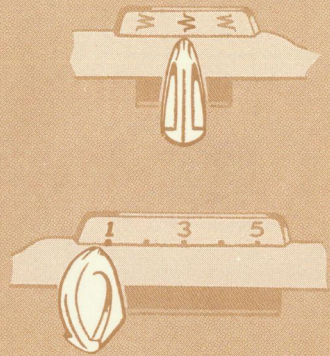
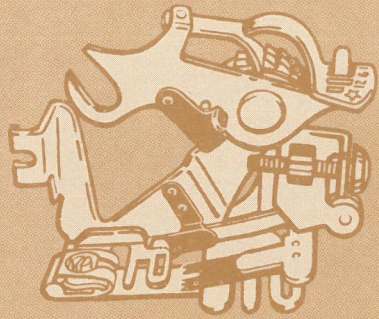
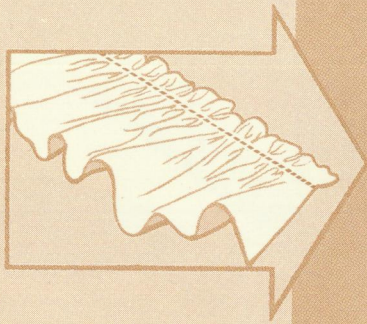

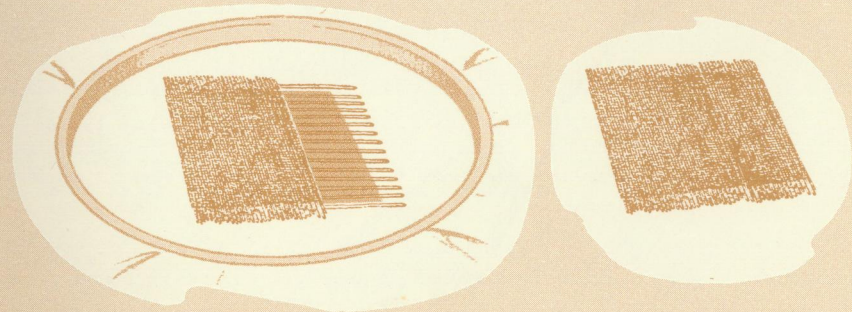
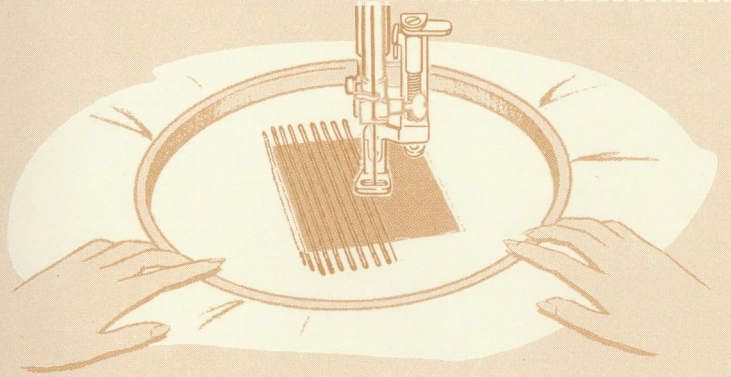
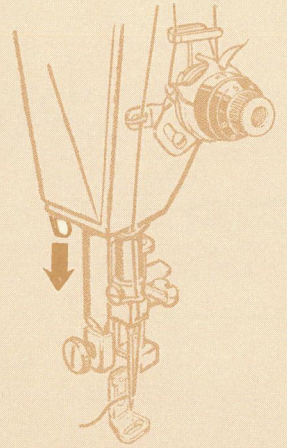
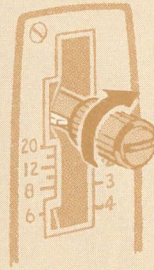
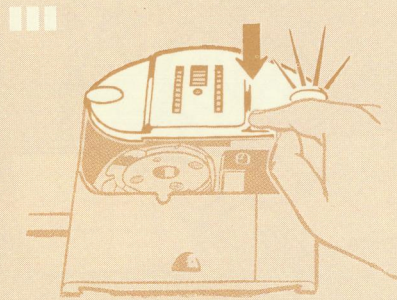
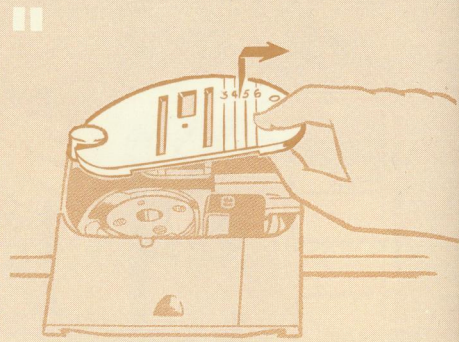
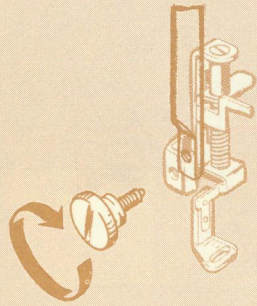
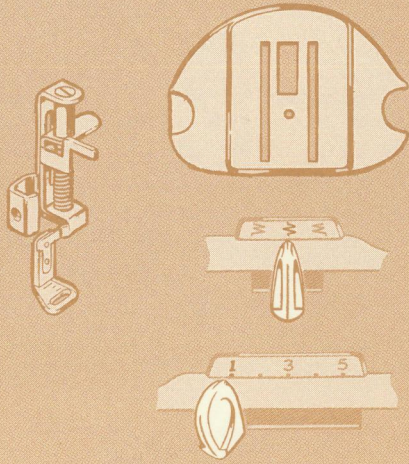
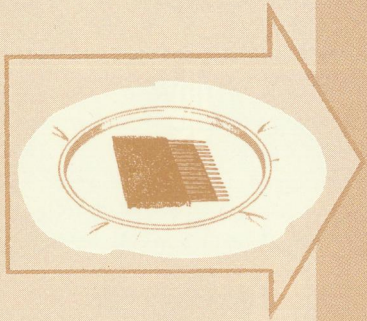

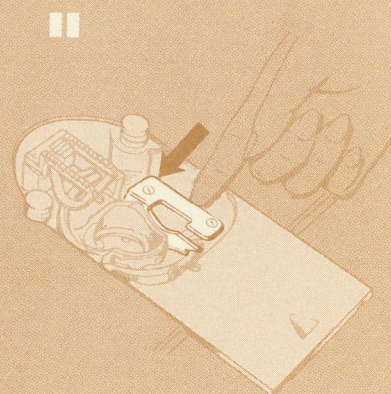
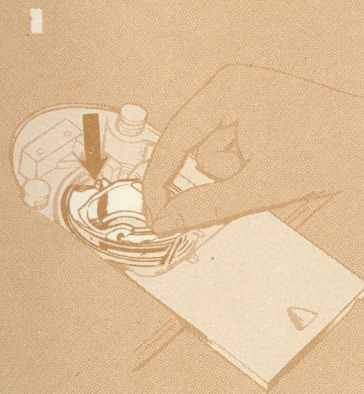
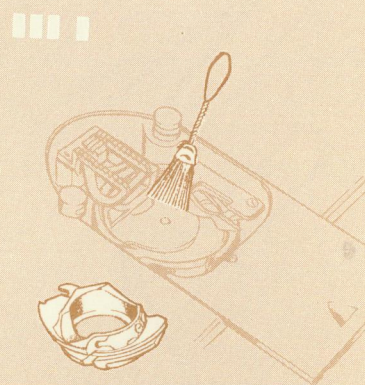
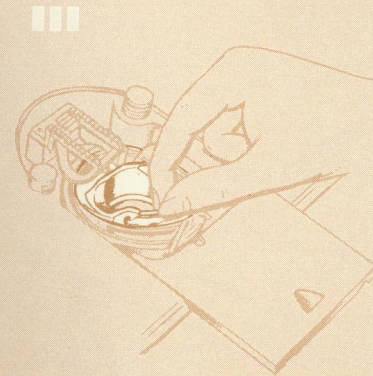
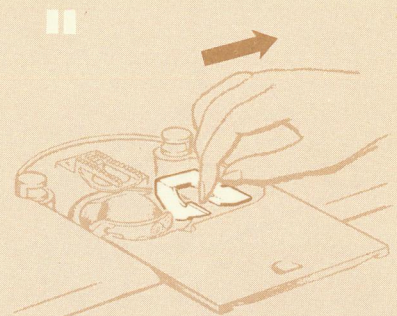
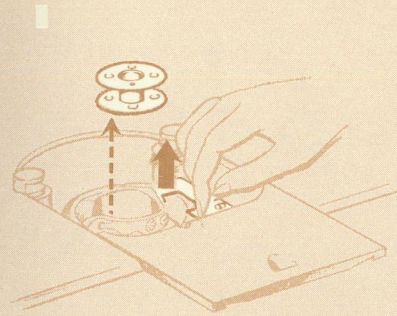
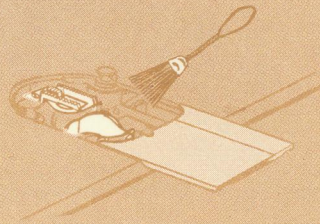
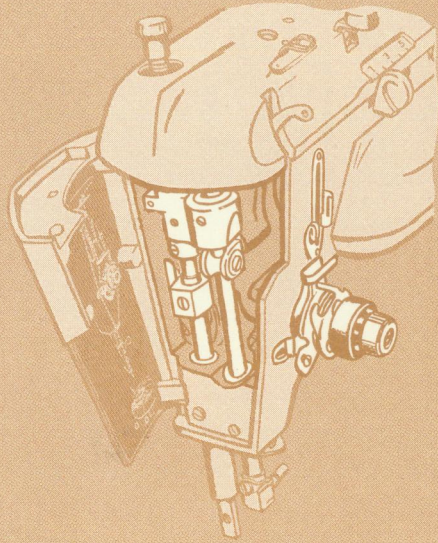
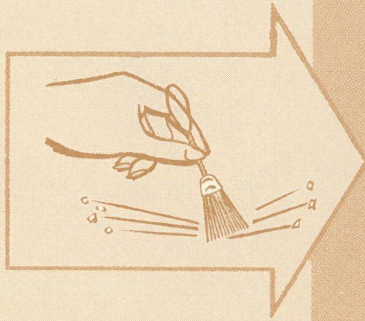

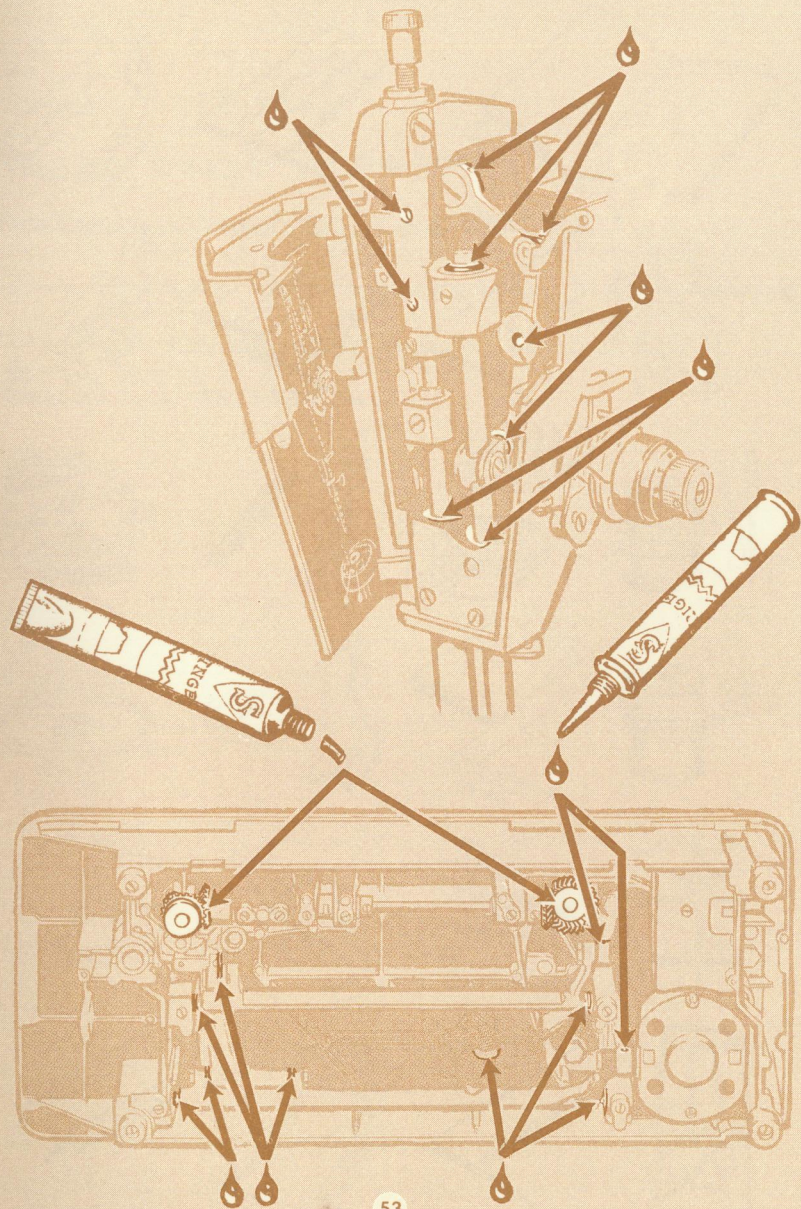
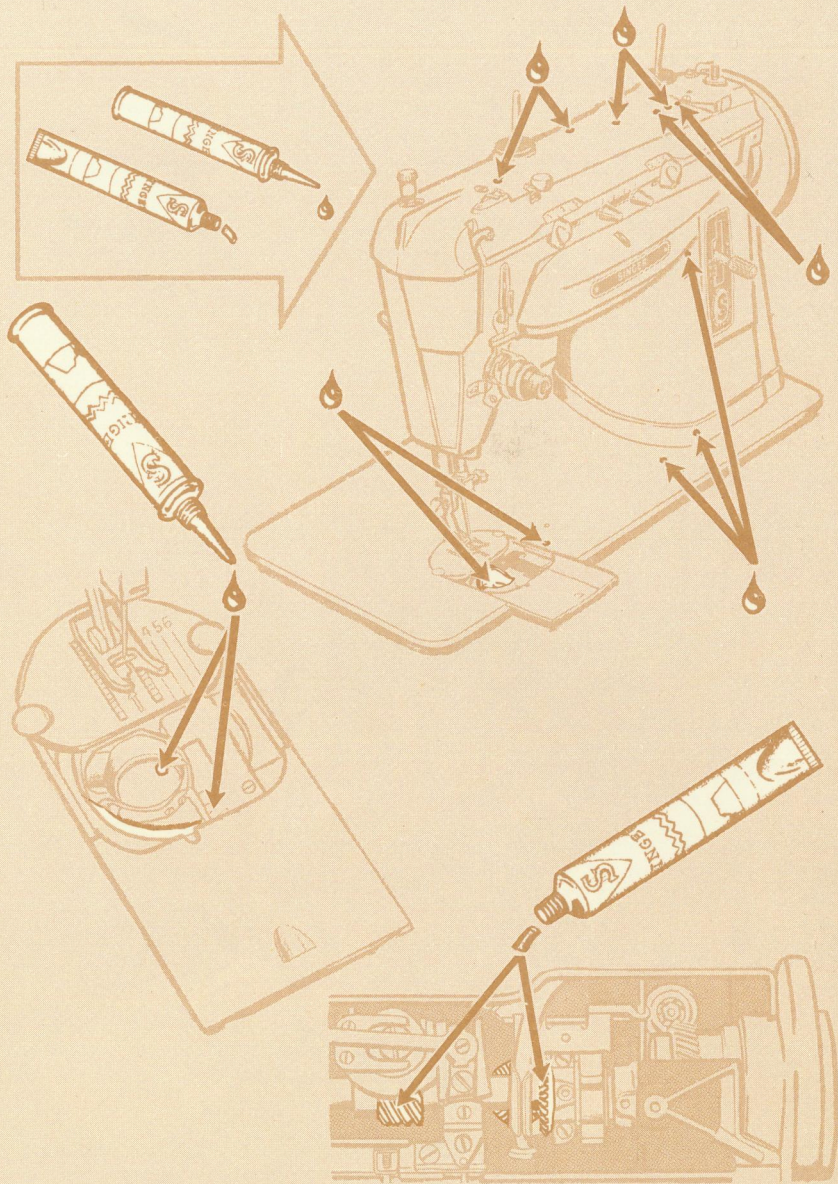

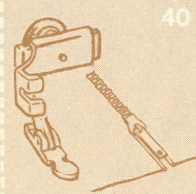
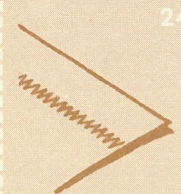
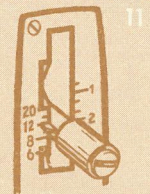
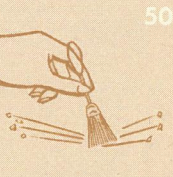
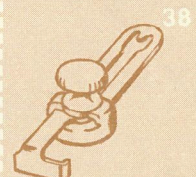
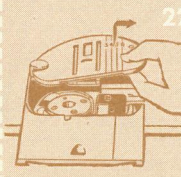
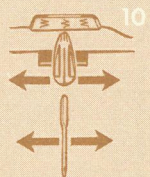
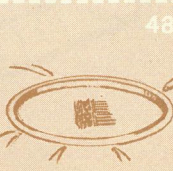
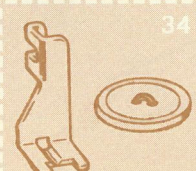
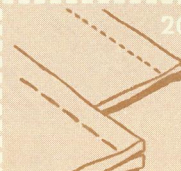
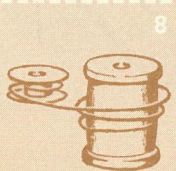
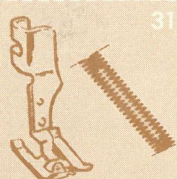
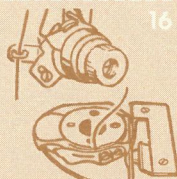
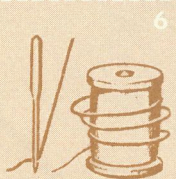
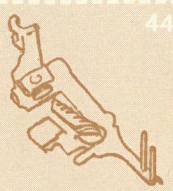
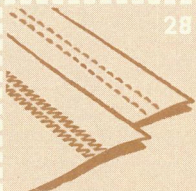
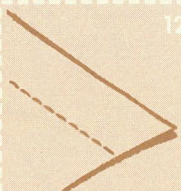
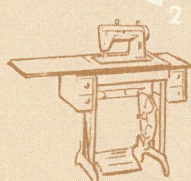
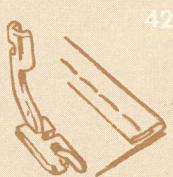
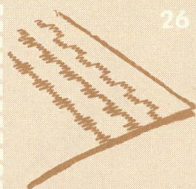
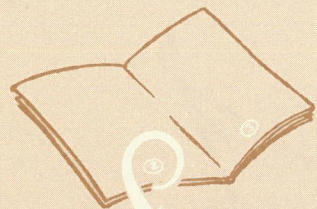

knoopsgaten.

breedte op. 3.

Trens op 5.

naald recht in de stof op 3
omdraaien naald uit de stof op 5.

Dan zorgen dat u links lang het knoopsgat
eindigt en verder op 3. Wel altijd
naald uit de stof.

